

CELLULAR MOBILE COMMUNICATION



Module-1

CELLULAR MOBILE RADIO SYSTEMS :

Introduction to Cellular Mobile System To describe cellular systems in general, it is necessary to include discussion of the basic cellular systems, their performance criteria, the uniqueness of the mobile radio environment, the operation of the cellular systems, reduction of cochannel interference, handoffs, and so forth.

BASIC CELLULAR SYSTEMS

There are two basic cellular systems; one is the circuit-switched system and the other is the packet-switched system.

Circuit-Switched Systems

In a circuit-switched system, each traffic channel is dedicated to a user until its call is terminated. We can further distinguish two circuit-switched systems: one for an analog system and one for a digital system.

A. Analog System

A basic analog cellular system^{1–3} consists of three subsystems: a mobile unit, a cell site, and a mobile telephone switching office (MTSO), as Fig. 2.1 shows, with connections to link the three subsystems.

- 1. Mobile units.** A mobile telephone unit contains a control unit, a transceiver, and an antenna system.
- 2. Cell site.** The cell site provides interface between the MTSO and the mobile units. It has a control unit, radio cabinets, antennas, a power plant, and data terminals.
- 3. MTSO.** The switching office, the central coordinating element for all cell sites, contains the cellular processor and cellular switch. It interfaces with telephone company zone offices, controls call processing, provides operation and maintenance, and handles billing activities.
- 4. Connections.** The radio and high-speed data links connect the three subsystems. Each mobile unit can only use one channel at a time for its communication link. But the channel is not fixed; it can be any one in the entire band assigned by the serving area, with each site having multichannel capabilities that can connect simultaneously to many mobile units.

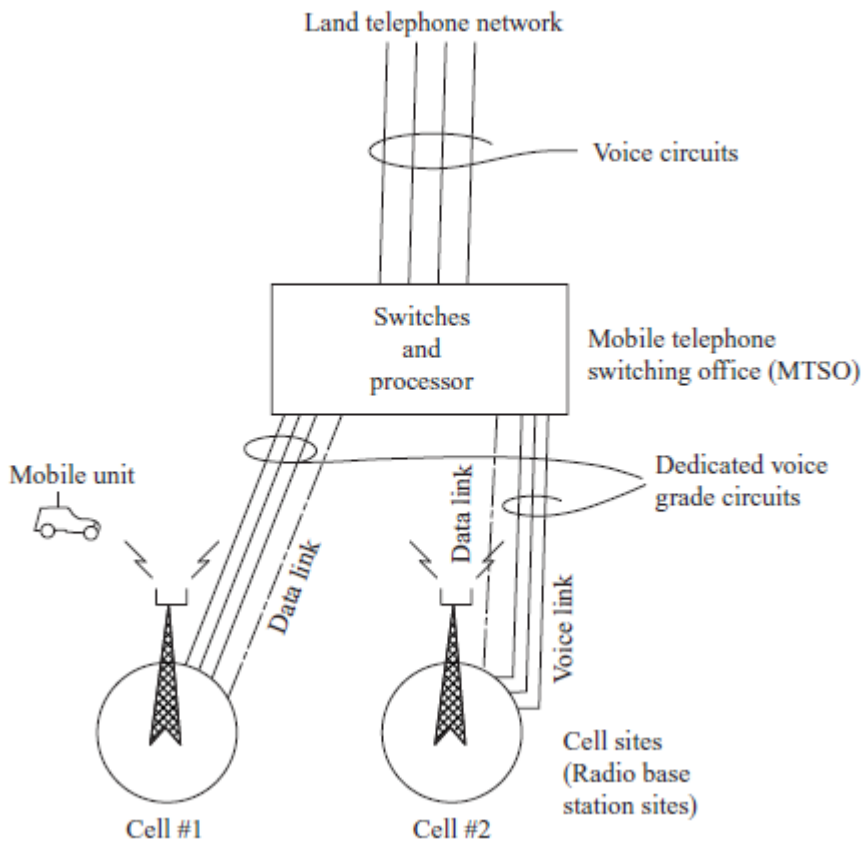
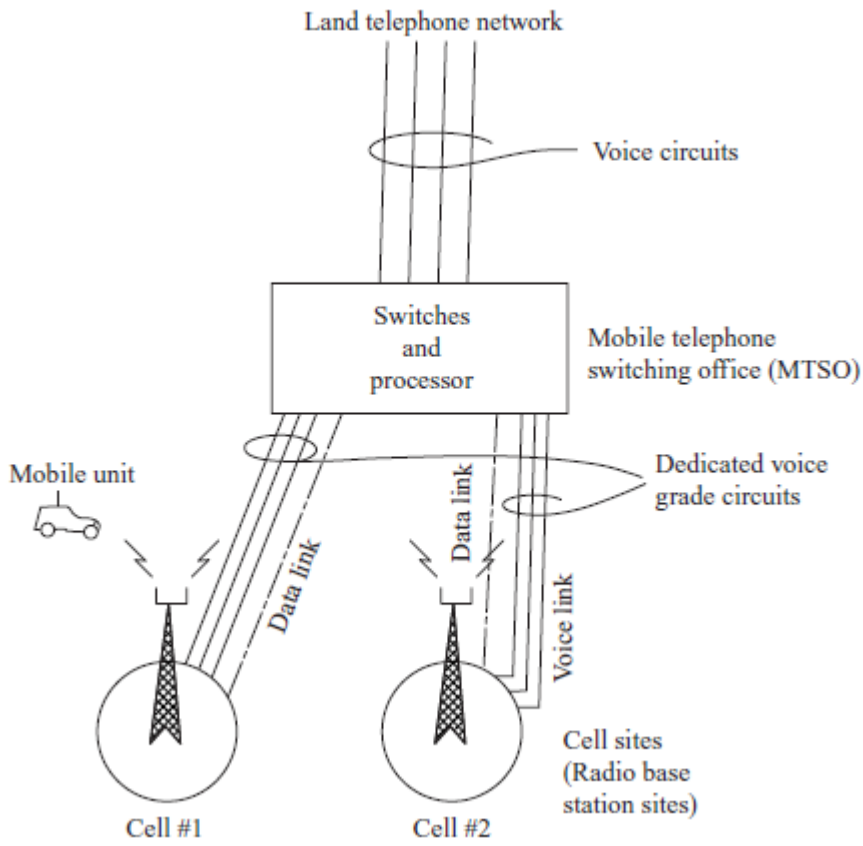

Performance criteria:

There are three categories for specifying performance criteria.

2.2.1 Voice Quality

Voice quality is very hard to judge without subjective tests for users' opinions. In this technical area, engineers cannot decide how to build a system without knowing the voice quality that will satisfy the users. In military communications, the situation differs: armed forces personnel must use the assigned equipment.

CM: For any given commercial communications system, the voice quality will be based on the following criterion: a set value x at which y percent of customers rate the system voice quality (from transmitter to receiver) as good or excellent; the top two circuit merits (CM) of the five listed below.

| CM | Score | Quality Scale |
|-----|-------|---|
| CM5 | 5 | Excellent (speech perfectly understandable) |
| CM4 | 4 | Good (speech easily understandable, some noise) |
| CM3 | 3 | Fair (speech understandable with a slight effort, occasional repetitions needed) |
| CM2 | 2 | Poor (speech understandable only with considerable effort, frequent repetitions needed) |
| CM1 | 1 | Unsatisfactory (speech not understandable) |

MOS: As the percentage of customers choosing CM4 and CM5 increases, the cost of building the system rises.

The average of the CM scores obtained from all the listeners is called mean opinion score (MOS). Usually, the toll-quality voice is around $MOS \geq 4$.

DRT (Diagnostic Rhyme Test): An ANSI standardized method used for evaluation of intelligibility. It is a subjective test method. Listeners are required to choose which word of a rhyming pair they perceived. The words differ only in their leading consonant. The word pairs have been chosen such that six binary attributes of speech intelligibility are measured in their present and absent states. This attribute profile provides a diagnostic capability to the test. For details on the attributes evaluated by the DRT check <http://www.arcon.com/tests.htm> and follow this link: ATTRIBUTES. To perform a sample DRT follows this link: DRT.

2.2.2 Data Quality

There are several ways to measure the data quality such as bit error rate, chip error rate, symbol error rate, and frame error rate. The chip error rate and symbol error rate are measuring the quality of data along the transmission path. The frame error rate and the bit error rate are measuring the quality of data at the throughput.

2.2.3 Picture/Vision Quality

There are color acuity, depth perception, flicker perception, motion perception, noise perception, and visual acuity. The percentage of pixel (picture element) loss rate can be characterized in vertical resolution loss and horizontal resolution loss of a pixel.

2.2.4 Service Quality

Three items are required for service quality.

1. Coverage. The system should serve an area as large as possible. With radio coverage, however, because of irregular terrain configurations, it is usually not practical to cover 100 percent of the area for two reasons:

a. The transmitted power would have to be very high to illuminate weak spots with sufficient reception, a significant added cost factor.

b. The higher the transmitted power, the harder it becomes to control interference.

Therefore, systems usually try to cover 90 percent of an area in flat terrain and 75 percent of an area in hilly terrain. The combined voice quality and coverage criteria in AMPS

uniqueness of mobile radio environment:

2.3.1 Description of Mobile Radio Transmission Medium

2.3.1.1 The Propagation Attenuation. In general, the propagation path loss increases not only with frequency but also with distance. If the antenna height at the cell site is 30 to 100 m and at the mobile unit about 3 m above the ground, and the distance between the cell site and the mobile unit is usually 2 km or more, then the incident angles of both the direct wave and the reflected wave are very small, as Fig. 2.4 shows. The incident angle of the direct wave is θ_1 , and the incident angle of the reflected wave is θ_2 . θ_1 is also called the *elevation angle*. The propagation path loss would be 40 dB/dec, where “dec” is an abbreviation of *decade*, i.e., a period of 10. This means that a 40-dB loss at a signal receiver will be observed by the mobile unit as it moves from 1 to 10 km. Therefore C is inversely proportional to R^4

$$C \propto R^{-4} = \alpha R^{-4} \quad (2.3-1)$$

where C = received carrier power

R = distance measured from the transmitter to the receiver

α = constant

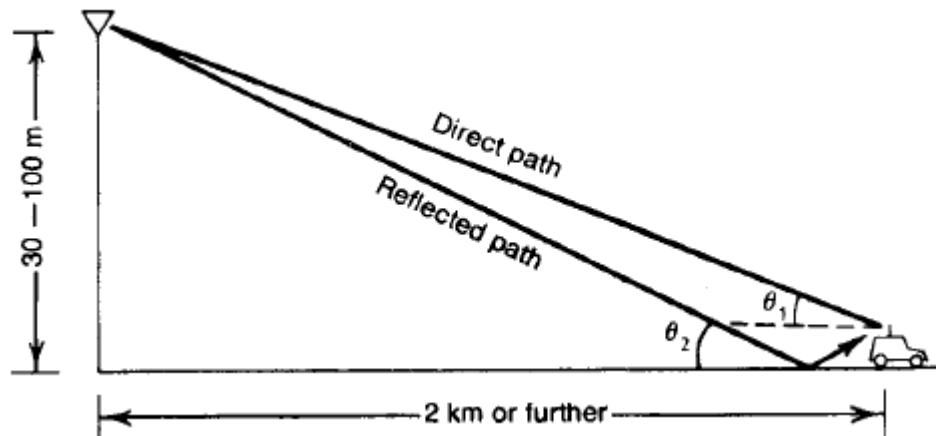

The difference in power reception at two different distances R_1 and R_2 will result in

$$\frac{C_2}{C_1} = \left(\frac{R_2}{R_1}\right)^{-4} \quad (2.3-2a)$$

and the decibel expression of Eq. (2.3-2a) is

$$\begin{aligned} \Delta C \text{ (in dB)} &= C_2 - C_1 \text{ (in dB)} \\ &= 10 \log \frac{C_2}{C_1} = 40 \log \frac{R_1}{R_2} \end{aligned} \quad (2.3-2b)$$

When $R_2 = 2R_1$, $\Delta C = -12$ dB; when $R_2 = 10R_1$, $\Delta C = -40$ dB.

This 40 dB/dec is the general rule for the mobile radio environment and is easy to remember. It is also easy to compare to the free-space propagation rule of 20 dB/dec. The linear and decibel scale expressions are

$$C \propto R^{-2} \quad (\text{free space}) \quad (2.3-3a)$$

and

$$\begin{aligned} \Delta C &= C_2 \text{ (in dB)} - C_1 \text{ (in dB)} \\ &= 20 \log \frac{R_1}{R_2} \quad (\text{free space}) \end{aligned} \quad (2.3-3b)$$

In a real mobile radio environment, the propagation path-loss slope varies as

$$C \propto R^{-\gamma} = \alpha R^{-\gamma} \quad (2.3-4)$$

γ usually lies between 2 and 5 depending on the actual conditions.⁵ Of course, γ cannot be lower than 2, which is the free-space condition. The decibel scale expression of Eq. (2.3-4) is

$$C = 10 \log \alpha - 10\gamma \log R \quad \text{dB} \quad (2.3-5)$$

2.3.1.2 Severe Fading. Because the antenna height of the mobile unit is lower than its typical surroundings, and the carrier frequency wavelength is much less than the sizes of the surrounding structures, multipath waves are generated. At the mobile unit, the sum of the multipath waves causes a signal-fading phenomenon. The signal fluctuates in a range

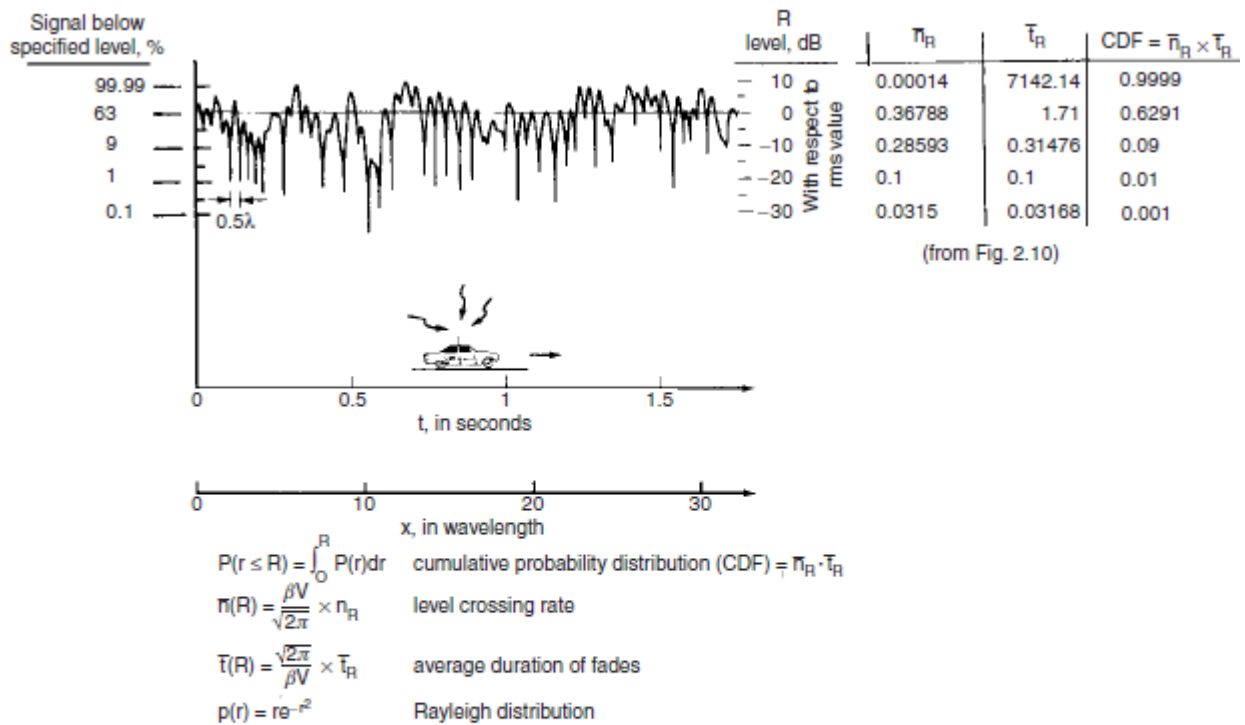

FIGURE 2.5 A typical fading signal received while the mobile unit is moving. (Reprint after Lee, Ref. 4, p. 54.)

of about 40 dB (10 dB above and 30 dB below the average signal). We can visualize the nulls of the fluctuation at the baseband at about every half wavelength in space, but all nulls do not occur at the same level, as Fig. 2.5 shows. If the mobile unit moves fast, the rate of fluctuation is fast. For instance, at 850 MHz, the wavelength is roughly 0.35 m (1 ft). If the speed of the mobile unit is 24 km/h (15 mi/h), or 6.7 m/s, the rate of fluctuation of the signal reception at a 10-dB level below the average power of a fading signal is 15 nulls per second (see Sec. 2.3.3).⁶

2.3.2 Model of Transmission Medium

A mobile radio signal $r(t)$, illustrated in Fig. 2.6, can be artificially characterized⁵ by two components $m(t)$ and $r_0(t)$ based on natural physical phenomena.

$$r(t) = m(t)r_0(t) \quad (2.3-6)$$

The component $m(t)$ is called *local mean*, *long-term fading*, or *lognormal fading* and its variation is due to the terrain contour between the base station and the mobile unit. The factor r_0 is called *multipath fading*, *short-term fading*, or *Rayleigh fading* and its variation is due to the waves reflected from the surrounding buildings and other structures. The long-term fading $m(t)$ can be obtained from Eq. (2.3-7a).

$$m(t_1) = \frac{1}{2T} \int_{t_1-T}^{t_1+T} r(t) dt \quad (2.3-7a)$$

where $2T$ is the time interval for averaging $r(t)$. T can be determined based on the fading rate of $r(t)$, usually 40 to 80 fades.⁵ Therefore, $m(t)$ is the envelope of $r(t)$, as shown in Fig.

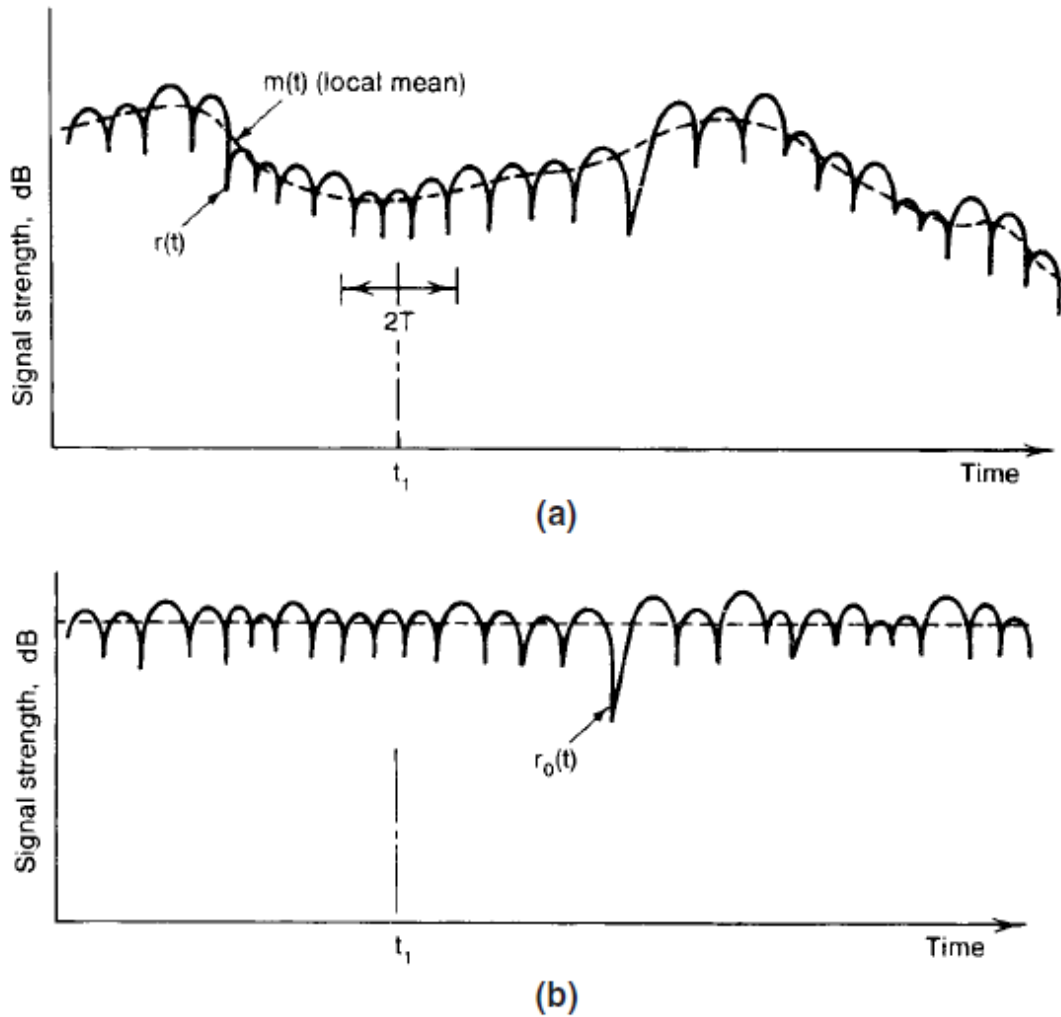

FIGURE 2.6 A mobile radio signal fading representation. (a) A mobile signal fading. (b) A short-term signal fading.

2.6a. Equation (2.3-7a) also can be expressed in spatial scale as

$$m(x_1) = \frac{1}{2L} \int_{x_1-L}^{x_1+L} r(x) dx \quad (2.3-7b)$$

The length of $2L$ has been determined to be 20 to 40 wavelengths.⁵ Using 36 or up to 50 samples in an interval of 40 wavelengths is an adequate averaging process for obtaining the local means.⁴

The factor $m(t)$ or $m(x)$ is also found to be a log-normal distribution based on its characteristics caused by the terrain contour. The short-term fading r_0 is obtained by

$$r_0 \text{ (in dB)} = r(t) - m(t) \quad \text{dB} \quad (2.3-8)$$

as shown in Fig. 2.6b. The factor $r_0(t)$ follows a Rayleigh distribution, assuming that only reflected waves from local surroundings are the ones received (a normal situation for the mobile radio environment). Therefore, the term *Rayleigh fading* is often used.

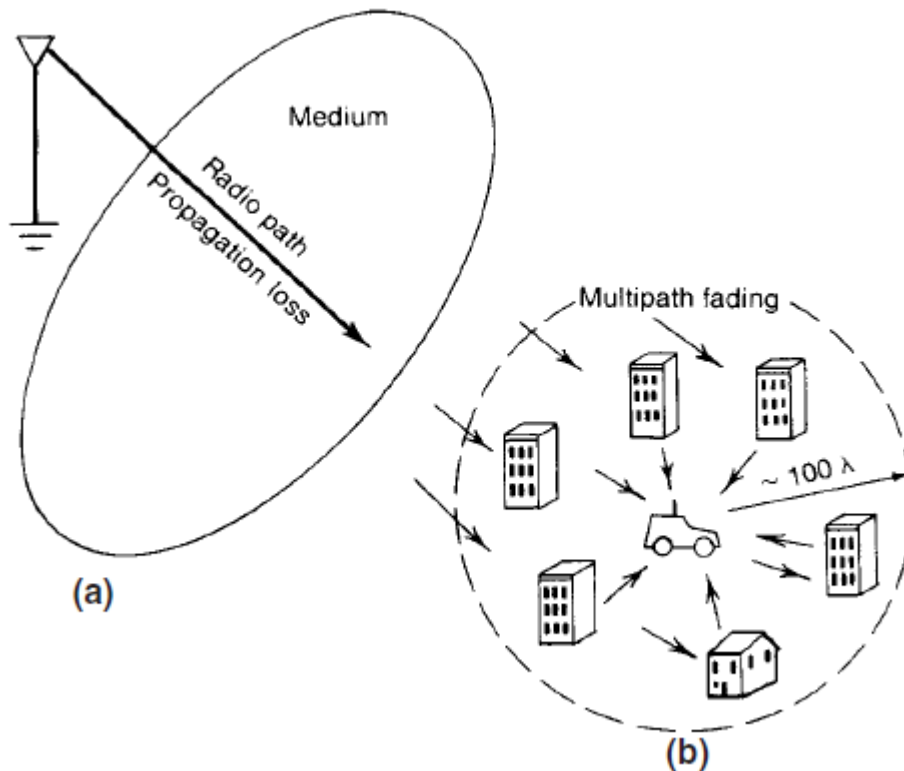

FIGURE 2.7 A mobile radio environment, two parts: (a) propagation loss; (b) multipath fading.

2.3.3 Mobile Fading Characteristics

Rayleigh fading is also called multipath fading in the mobile radio environment. When these multipath waves bounce back and forth due to the buildings and houses, they form many standing-wave pairs in space, as shown in Fig. 2.7. Those standing-wave pairs are summed together and become an irregular wave-fading structure. When a mobile unit is standing still, its receiver only receives a signal strength at that spot, so a constant signal is observed. When the mobile unit is moving, the fading structure of the wave in the space is received. It is a multipath fading. The recorded fading becomes fast as the vehicle moves faster.

2.3.3.1 The Radius of the Active Scatterer Region. The mobile radio multipath fading shown in Fig. 2.7 explains the fading mechanism. The radius of the active scatterer region at 850 MHz can be obtained indirectly as shown in Ref. 7. The radius is roughly 100 wavelengths. The active scatterer region always moves with the mobile unit as its center. It means that some houses were inactive scatterers and became active as the mobile unit approached them; some houses were active scatterers and became inactive as the mobile unit drove away from them.

2.3.3.2 Standing Waves Expressed in a Linear Scale and a Log Scale. We first introduce a sine wave in a log scale.

$$y = 10 \cos \beta x \text{ dB} \quad (2.3-9)$$

A log plot of the sine wave of Eq. (2.3-9) is shown in Fig. 2.8a. The linear expression of Eq. (2.3-9) then is shown in Fig. 2.8b. The symmetrical waveform in a log plot becomes an unsymmetrical waveform when plotted on a linear scale. It shows that the sine wave

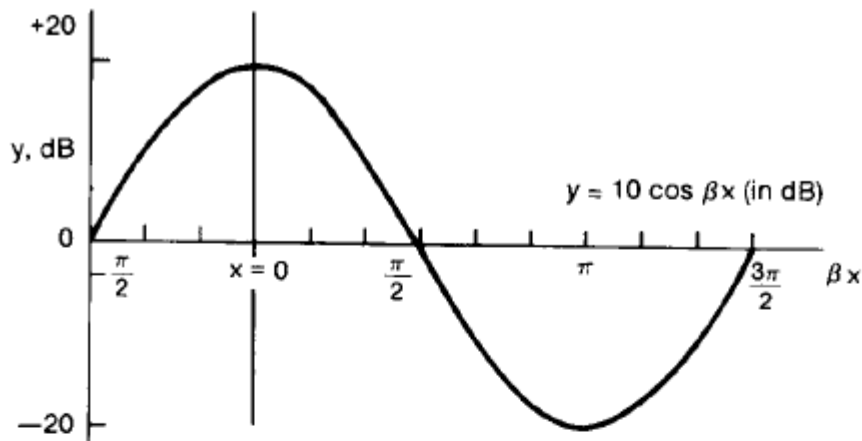

(a)

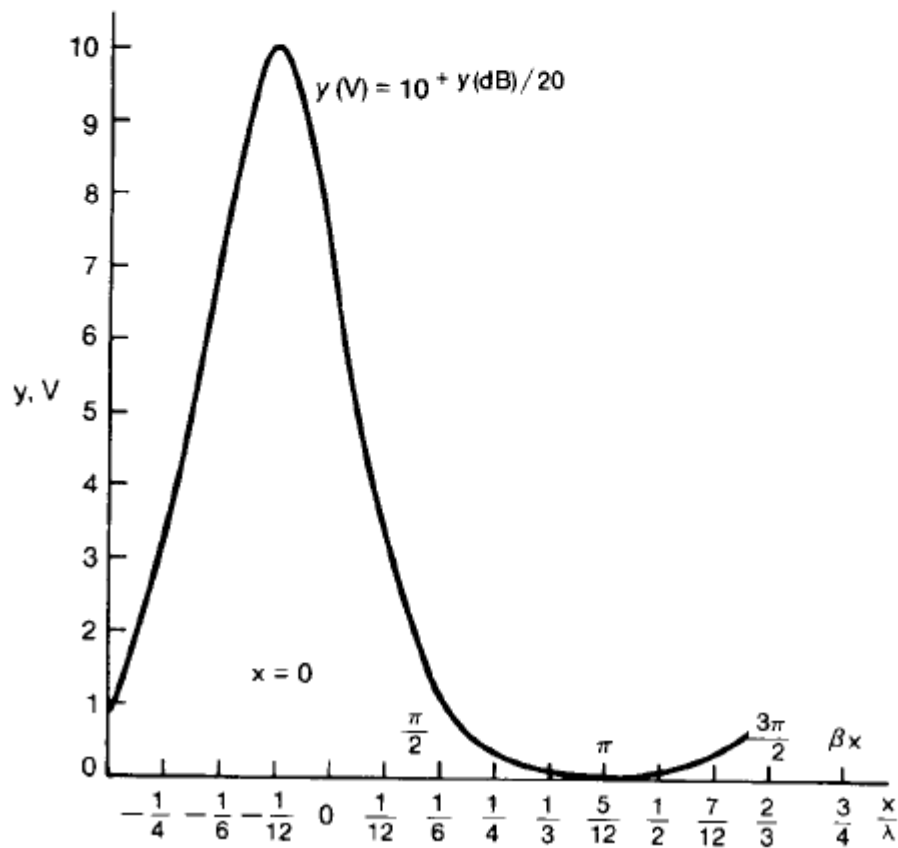

(b)

FIGURE 2.8 The linear plot and the log plot of a sine wave. (a) In linear scale; (b) in log scale.

waveform in a log scale becomes a completely different waveform when expressed on a linear scale and vice versa. Two sine waves, the incident wave traveling along the x -axis (traveling to the left) and the reflected wave traveling in the opposite direction, can be expressed as

$$e_0 = E_0 e^{j(\omega t - \beta x)} \quad (2.3-10)$$

$$e_1 = E_1 e^{j(\omega t + \beta x + 2\delta)}$$

where ω = angular frequency
 β = wave number ($= 2\pi/\lambda$)
 2δ = time-phase lead of e_1 with respect to e_0 at $x = 0$

The two waves form a standing-wave pattern.

$$e = e_0 + e_1 = Re^{j(\omega t + \delta + \varphi)} \quad (2.3-12)$$

where φ is the phase angle of the two waves at $x \neq 0$, and the amplitude R becomes

$$R = \sqrt{(E_0 + E_1)^2 \cos^2(\beta x + \delta) + (E_0 - E_1)^2 \sin^2(\beta x + \delta)} \quad (2.3-13)$$

We are plotting two cases and assuming $\delta = 0$.

Case 1. $E_0 = 1, E_1 = 1$; that is, the reflection coefficient = 1,

$$\text{Standing wave ratio (SWR)} = \frac{E_0 + E_1}{E_0 - E_1} = \infty$$

and $R = 2 \cos \beta x$ (2.3-14)

Case 2. $E_0 = 1, E_1 = 0.5$; that is, the reflection coefficient = 0.5, SWR = 3, and

$$R = \sqrt{(1.5)^2 \cos^2 \beta x + (0.5)^2 \sin^2 \beta x} \quad (2.3-15)$$

The linear expression of Eqs. (2.3-14) and (2.3-15) are shown in Fig. 2.9a. The log-scale expression of Eqs. (2.3-14) and (2.3-15) are shown in Fig. 2.9b. The waveform of Fig. 2.9b is the first sign of the fading signal, which resembles the real fading signal shown in Fig. 2.5.

2.3.3.3 First-Order and Second-Order Statistics of Fading.^{5,6} Fading occurs on the signal reception when the mobile unit is moving. The first-order statistics, such as average power probability cumulative distribution function (CDF) and bit error rate, are independent of time. The second-order statistics, such as level crossing rate, average duration of fades, and word error rate, are time functions or velocity-related functions. The data signaling format is based on these characteristics. The description of the fading characteristic can be found in detail in two books, Refs. 4 and 5.

Some data can be found from Fig. 2.10a, the cumulative distribution function (CDF), and Fig. 2.10b, the level crossing rate. In Fig. 2.10a, the equation of CDF for a Rayleigh fading is used as follows:

$$P(r \leq R) = 1 - e^{-R^2/\overline{R^2}} \quad (2.3-16)$$

and $P(y \leq L) = 1 - e^{-L/\overline{L}}$ (2.3-17)

where $\overline{R^2}$ and \overline{L} are the mean square value and the average power, respectively. In Fig. 2.10a, about 9 percent of the total signal is below a level of -10 dB with respect to average power. In Fig. 2.10b, the level crossing rate (lcr) at a level R is

$$\overline{n}(R) = \frac{\beta v}{\sqrt{2\pi}} n_R \quad (2.3-18)$$

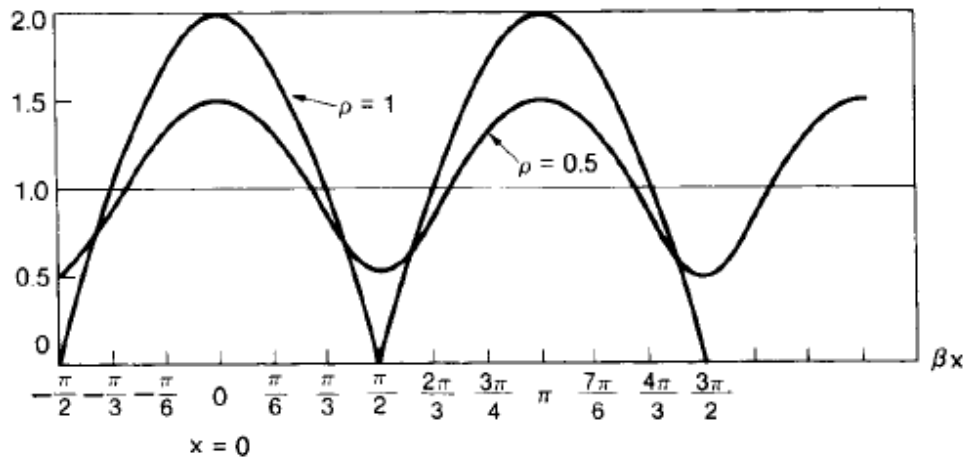

(a)

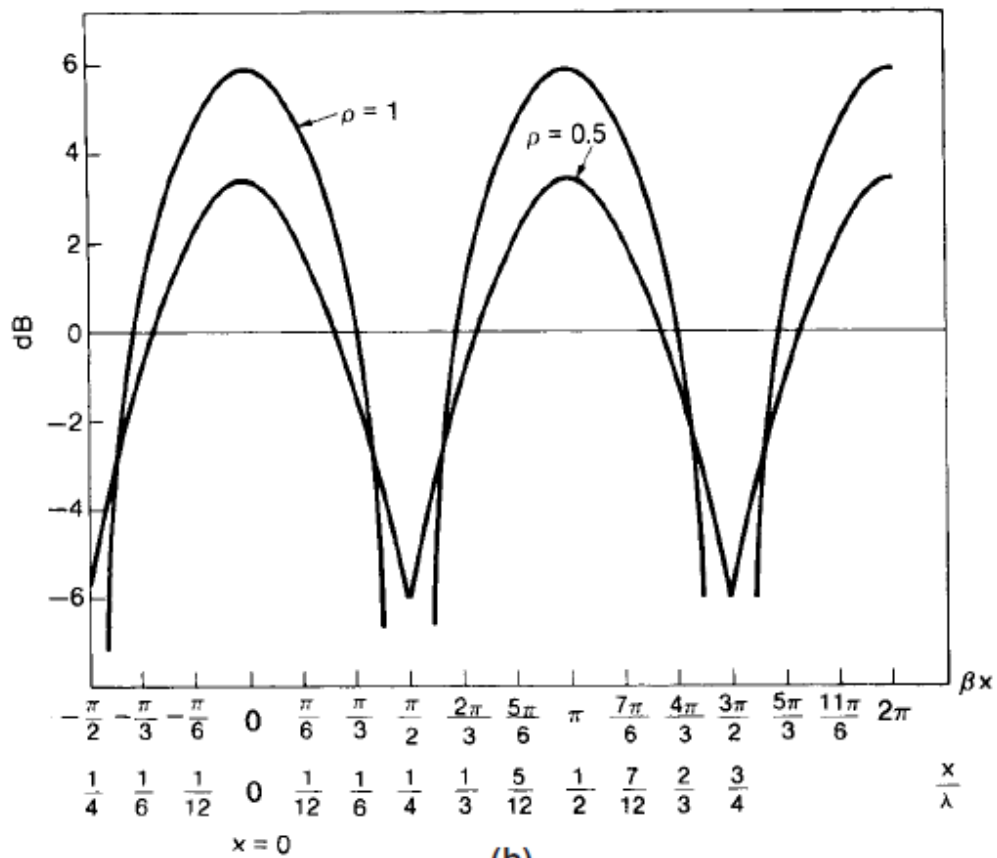

(b)

FIGURE 2.9 The linear plot and the log plot of a standing wave. (a) In linear scale; (b) in log scale.

where n_R is the normalized lcr which is independent of wavelength and the car speed. At a level of -10 dB, $n_0 = 0.3$ can be found from Fig. 2.10b. Assume that a signal of 850 MHz is received at a mobile unit with a velocity of 24 km/h (15 mi/h). Then

$$n_0 = \frac{\beta V}{\sqrt{2\pi}} = 50$$

and

$$\bar{n} = 50 \times 0.3 = 15$$

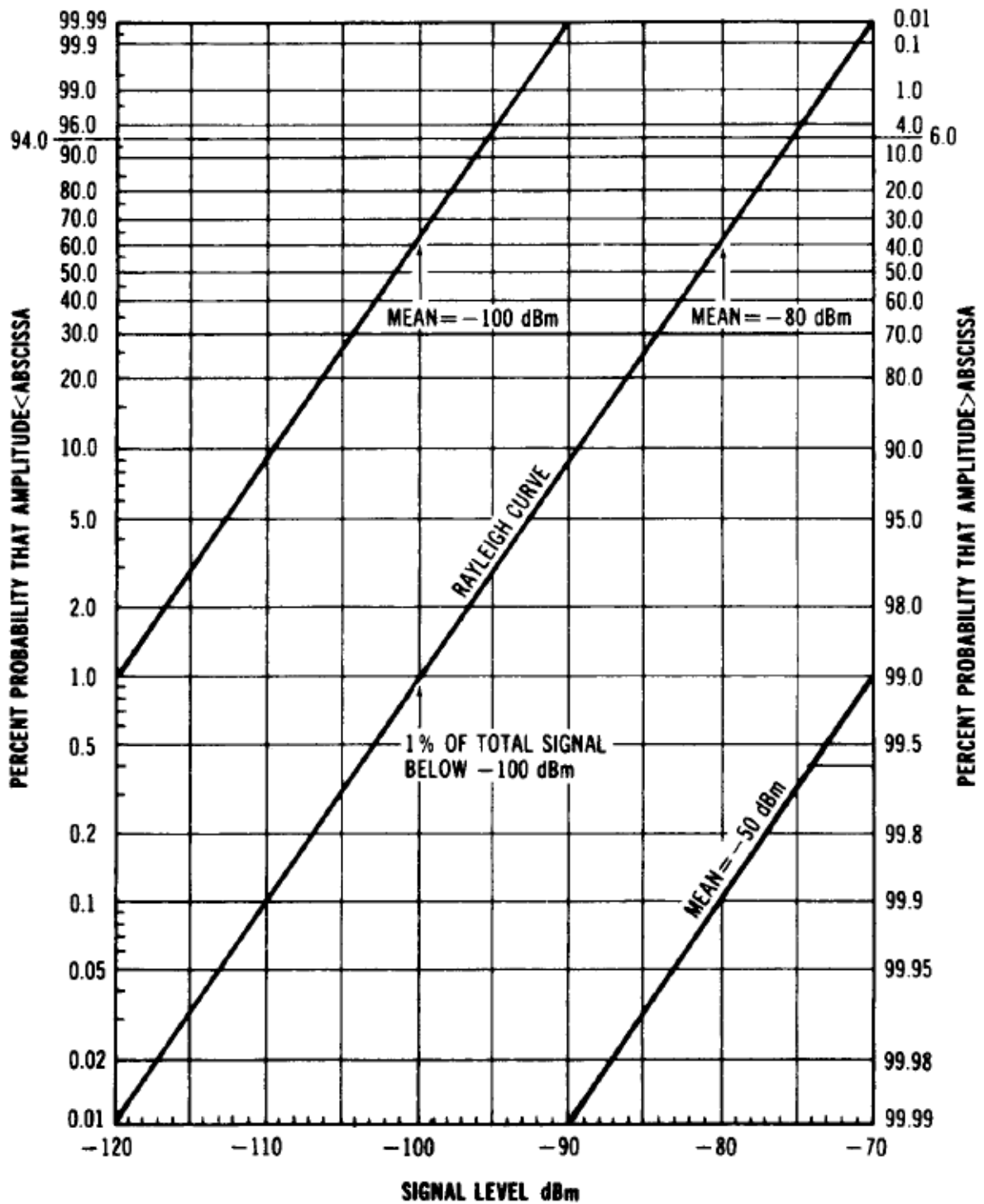

(a)

FIGURE 2.10 Fading characteristics. (a) CDF. (After Lee, Ref. 8, p. 30.)

Therefore, at a cellular frequency of 800 MHz and a vehicle velocity of 15 mi/h, the level crossing rate is 15 per second. It is easy to remember.

The average duration of fade is⁶

$$\bar{t} = \frac{\text{CDF}}{\bar{f}_0 \bar{f}_R} = \frac{\text{CDF}}{\bar{n}} \quad (2.3-19)$$

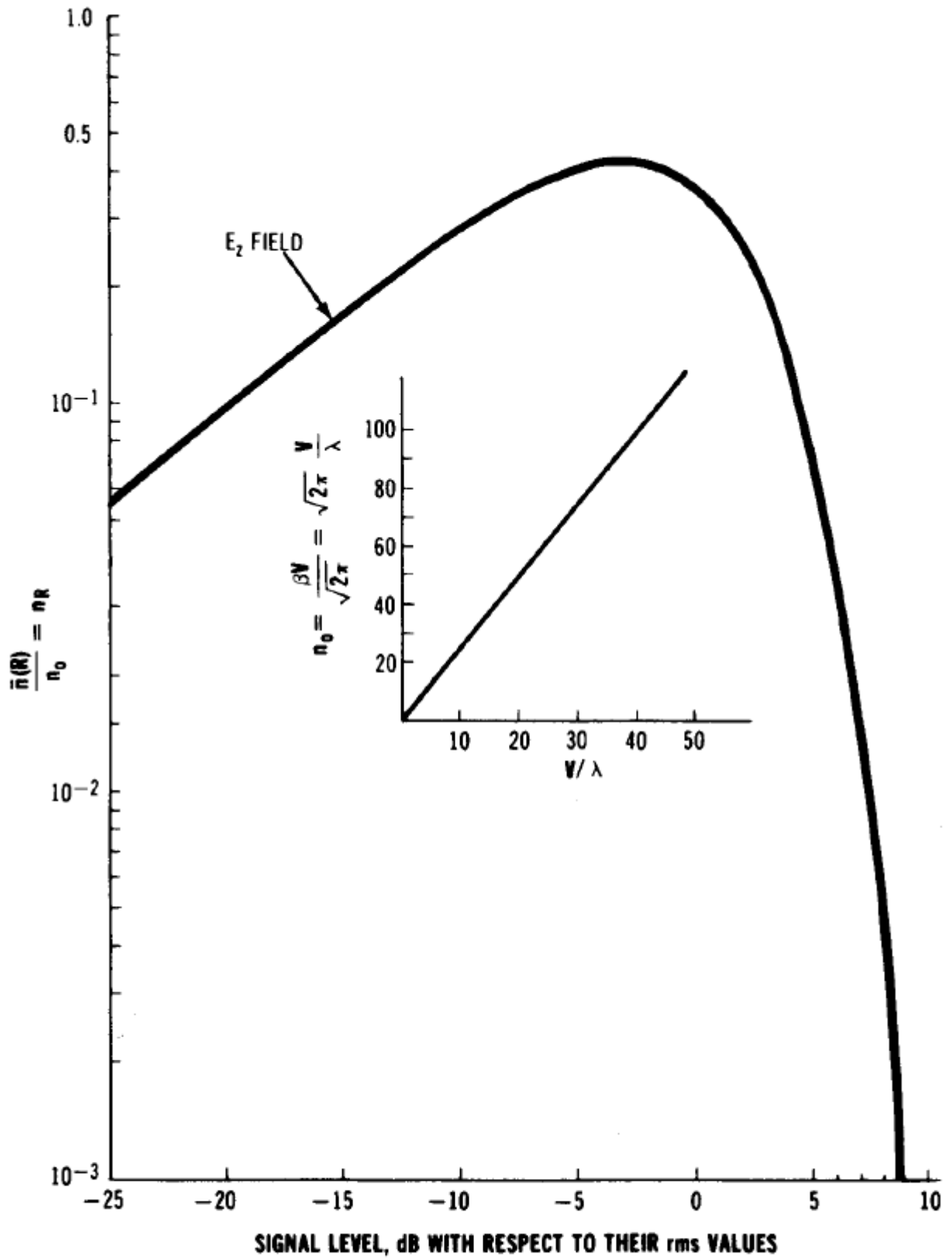

(b)

FIGURE 2.10 (Continued) (b) Level crossing rate.

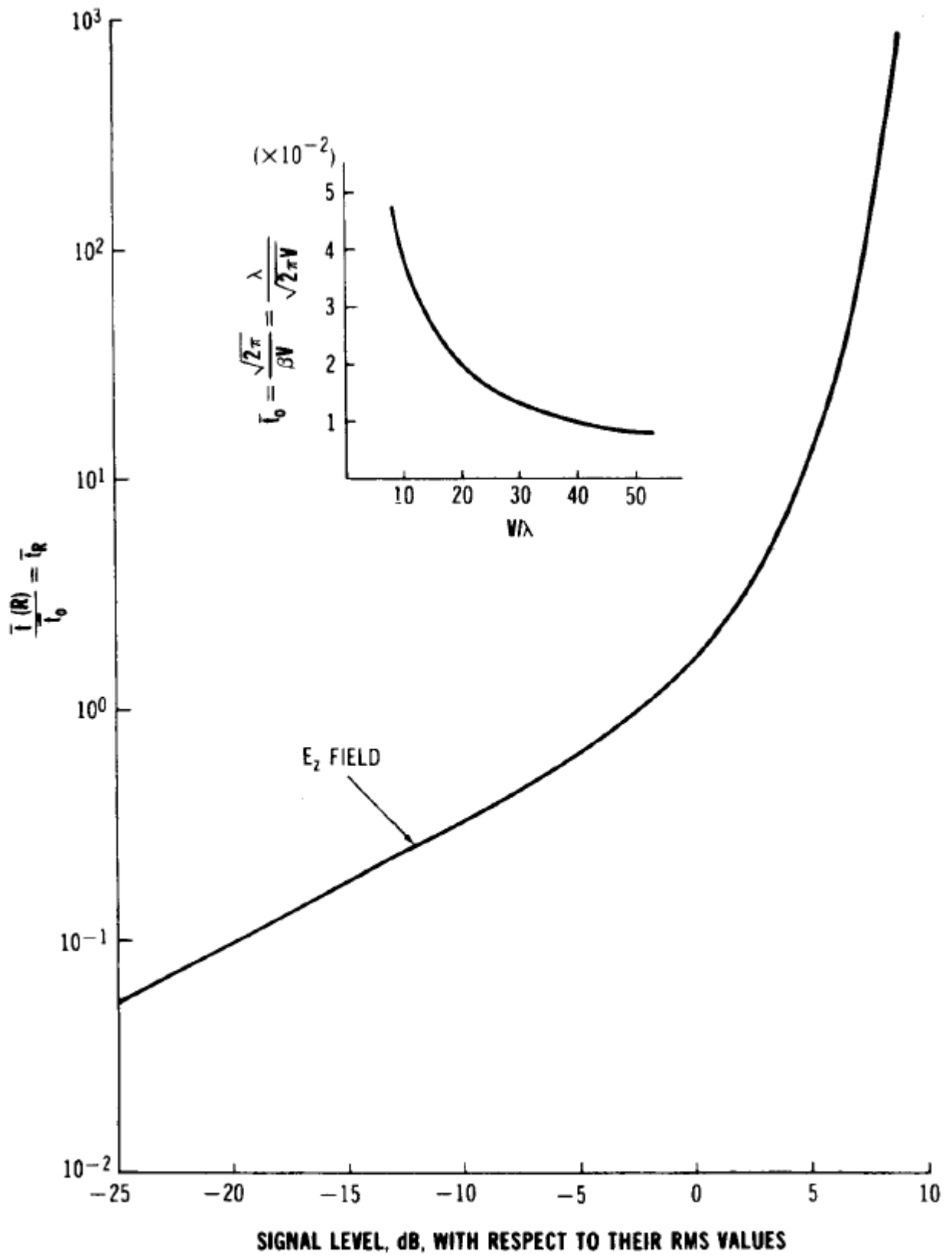

(c)

FIGURE 2.10 (Continued) (c) Average duration of fades.

Equation (2.3-19) is plotted in Fig. 2.10c, where t_0 and t_R are also shown. At -10 dB, the average duration of fades is

$$\bar{t}_R = \frac{\text{CDF}}{\bar{n}_R} = 0.0066 \text{ s} = 6.6 \text{ ms}$$

Now the average power level plays an important role in determining the statistics. Therefore, it should be specified by the system design. The second-order statistic of fading phenomenon is most useful for designing a signaling format for the cellular system. As soon as the signaling format is specified, we can calculate the bit error rate and the word error rate and find ways to reduce the error rates, which will be described in Sec. 15.2.

2.3.3.4 Delay Spread and Coherence Bandwidth

Delay spread. In the mobile radio environment, as a result of the multipath reflection phenomenon, the signal transmitted from a cell site and arriving at a mobile unit will be from different paths, and since each path has a different path length, the time of arrival for each path is different. For an impulse transmitted at the cell site, by the time this impulse is received at the mobile unit, it is no longer an impulse but rather a pulse with a spread width that we call the *delay spread*. The measured data indicate that the mean delay spreads are different in different kinds of environment.

| Type of Environment | Delay Spread Δ , μs |
|---------------------|---------------------------------------|
| Inside the building | <0.1 |
| Open area | <0.2 |
| Suburban area | 0.5 |
| Urban area | 3 |

Coherence bandwidth. The coherence bandwidth is the defined bandwidth in which either the amplitudes or the phases of two received signals have a high degree of similarity. The delay spread is a natural phenomenon, and the coherence bandwidth is a defined creation related to the delay spread.

A coherence bandwidth for two fading amplitudes of two received signals is

$$B_c = \frac{1}{2\pi \Delta}$$

A coherence bandwidth for two random phases of two received signals is

$$B'_c = \frac{1}{4\pi \Delta}$$

2.3.4 Direct Wave Path, Line-of-Sight Path, and Obstructive Path

A *direct wave path* is a path clear from the terrain contour. The *line-of-sight path* is a path clear from buildings. In the mobile radio environment, we do not always have a line-of-sight condition.

When a line-of-sight condition occurs, the average received signal of the mobile unit at a 1-mi intercept is higher, although the 40 dB/dec path-loss slope remains the same. It

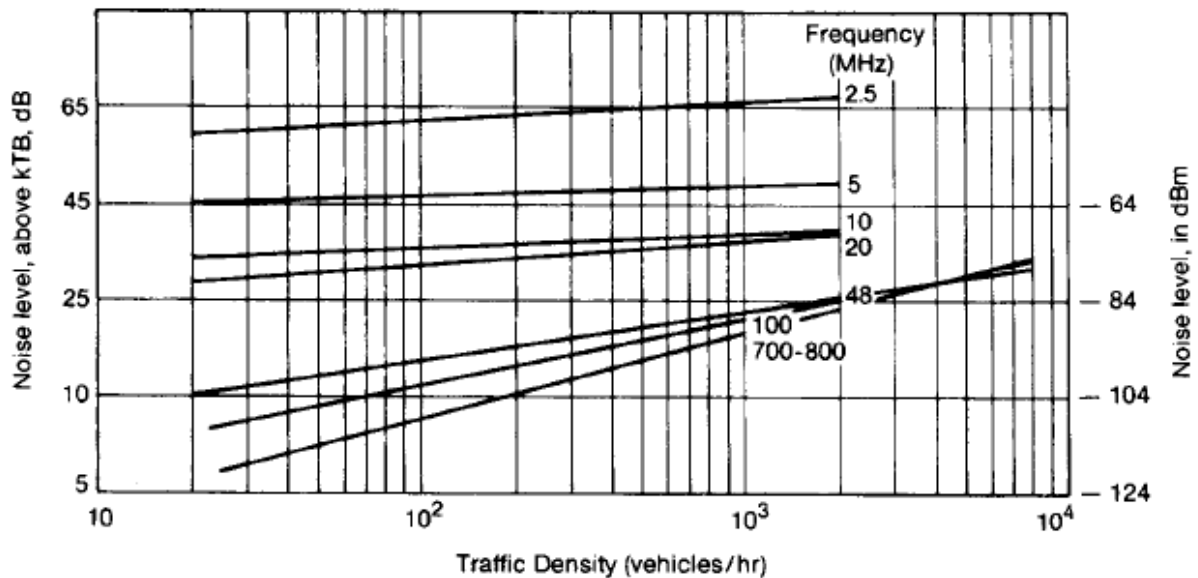

FIGURE 2.11 Average automotive-traffic-noise power for various traffic densities and frequencies. Detector noise bandwidth 30 kHz at room temperature (17°C). (After Lee, Ref. 12.)

will be described in Sec. 8.2. In this case, the short-term fading is observed to be a rician fading.⁸ It results from a strong line-of-sight path and a ground-reflected wave combined, plus many weak building-reflected waves.

When an out-of-sight condition is reached, the 40-dB/dec path-loss slope still remains. However, all reflected waves, including ground reflected waves and building-reflected waves, become dominant. The short-term received signal at the mobile unit observes a Rayleigh fading. The Rayleigh fading is the most severe fading.

When the terrain contour blocks the direct wave path, we call it the *obstructive path*. In this situation, the shadow loss from the signal reception can be found by using the knife-edge diffraction curves shown in Sec. 8.7.2.

2.3.5 Noise Level in Cellular Frequency Band

The thermal noise kTB at a temperature T of 290 K (17°C) and a bandwidth B of 30 kHz is -129 dBm.* Assume that the received front-end noise is 9 dB, then the noise level is -120 dBm. Now there are two kinds of man-made noise, the ignition noise generated by the vehicles and the noise generated by 800-MHz emissions.

2.3.5.1 The Ignition Noise. In the past, 800 MHz was not widely used. Therefore, the man-made noise at 800 MHz is merely generated by the vehicle ignition noise.¹⁰ The automotive noise¹¹ introduced at 800 MHz with a bandwidth of 30 kHz can be deduced from Ref. 12, as shown in Fig. 2.11.

2.3.5.2 The 800-MHz-Emission Noise. As a result of the cellular mobile systems operating in all the major cities in the United States and the spurious energy generated outside each channel bandwidth, the early noise data measurements¹⁰ are no longer valid. The 800-MHz-emission noise can be measured at an idle channel (a forward voice channel) in the 869- to 894-MHz region while the mobile receiver is operating on a car battery in

* k is Boltzmann's constant, and $kT = -174$ dBm/Hz at $T = 290$ K.⁹

a no-traffic spot in a city. In this case, no automotive ignition noise is involved, and no cochannel operation is in the proximity of the idle-channel receiver. We found that in some areas the noise level is 2 to 3 dB higher than -120 dBm at the cell sites and 3 to 4 dB higher than -120 dBm at the mobile stations.

2.3.5.3 Emission Noise Above the 800 MHz. Up to the operating frequency of 3 GHz, the emission noise level may remain the same level as that at the 800 MHz. Usually, the emission noise can be ignored because the interference level caused by the cochannels and adjacent channels is much higher than the emission noise level.

2.3.6 Amplifier Noise

A mobile radio signal received by a receiving antenna, either at the cell site or at the mobile unit, will be amplified by an amplifier. We would like to understand how the signal is affected by the amplifier noise. Assume that the amplifier has an available power gain g and the available noise power at the output is N_o . The input signal-to-noise (S/N) ratio is P_s/N_i , the output signal-to-noise ratio is P_o/N_o , and the internal amplifier noise is N_α . Then the output P_o/N_o becomes

$$\frac{P_o}{N_o} = \frac{gP_s}{g(N_i) + N_\alpha} = \frac{P_s}{N_i + (N_\alpha/g)} \quad (2.3-20)$$

The noise figure F is defined as

$$F = \frac{\text{maximum possible S/N ratio}}{\text{actual S/N ratio at output}} \quad (2.3-21)$$

where the maximum possible S/N ratio is measured when the load is an open circuit. Equation (2.3-21) can be used for obtaining the noise figure of the amplifier.

$$F = \frac{P_s/kTB}{P_o/N_o} = \frac{N_o}{(P_o/P_s)kTB} = \frac{N_o}{g(kTB)} \quad (2.3-22)$$

Also substituting Eq. (2.3-20) into Eq. (2.3-22) yields

$$F = \frac{P_s/kTB}{P_s/[N_i + (N_\alpha/g)]} = \frac{N_i + (N_\alpha/g)}{kTB} \quad (2.3-23)$$

The term kTB is the thermal noise as described in Sec. 2.3-5. The noise figure is a reference measurement between a minimum noise level due to thermal noise and the noise level generated by both the external and internal noise of an amplifier.

Operation of cellular systems

This section briefly describes the operation of the cellular mobile system from a customer's perception without touching on the design parameters.^{13,14} The operation can be divided into four parts and a handoff procedure.

Mobile unit initialization. When a user activates the receiver of the mobile unit, the

receiver scans the set-up channels. It then selects the strongest and locks on for a certain time. Because each site is assigned a different set-up channel, locking onto the strongest set-up channel usually means selecting the nearest cell site. This self-location scheme is used in the idle stage and is user-independent. It has a great advantage because it eliminates the load on the transmission at the cell site for locating the mobile unit. The disadvantage of the self-location scheme is that no location information of idle mobile units appears at each cell site. Therefore, when the call initiates from the land line to a mobile unit, the paging process is longer. For a large percentage of calls originates at the mobile unit, the use of self-location schemes is justified. After a given period, the self-location procedure is repeated. When land-line originated calls occur, a feature called "registration" is used.

Mobile originated call. The user places the called number into an originating register in the mobile unit, and pushes the "send" button. A request for service is sent on a selected set-up channel obtained from a self-location scheme. The cell site receives it, and in directional cell sites (or sectors), selects the best directive antenna for the voice channel to use. At the same time, the cell site sends a request to the mobile telephone switching office (MTSO) via a high-speed data link. The MTSO selects an appropriate voice channel for the call, and the cell site acts on it through the best directive antenna to link the mobile unit. The MTSO also connects the wire-line party through the telephone company zone office.

Network originated call. A land-line party dials a mobile unit number. The telephone company zone office recognizes that the number is mobile and forwards the call to the MTSO. The MTSO sends a paging message to certain cell sites based on the mobile unit number and the search algorithm. Each cell site transmits the page on its own set-up channel. If the mobile unit is registered, the registered site pages the mobile. The mobile unit recognizes its own identification on a strong set-up channel, locks onto it, and responds to the cell site. The mobile unit also follows the instruction to tune to an assigned voice channel and initiate user alert.

Call termination. When the mobile user turns off the transmitter, a particular signal (signaling tone) transmits to the cell site, and both sides free the voice channel. The mobile unit resumes monitoring pages through the strongest set-up channel.

Handoff procedure. During the call, two parties are on a traffic channel. When the mobile unit moves out of the coverage area of a particular cell site, the reception becomes weak. The current cell site requests a handoff. The system switches the call to a new frequency channel in a new cell site without either interrupting the call or alerting the user. The call continues as long as the user is talking. The user does not notice the handoff occurrences. *Handoff* was first used by the AMPS system, then renamed *handover* by the European systems because of the different meanings in British English and American English.

Module-II

Elements of Cellular Radio System Design:

General description of the problem

Maximum Number of Calls Per Hour Per Cell

To calculate the predicted number of calls per hour per cell Q in each cell, we have to know the size of the cell and the traffic conditions in the cell. The calls per hour per cell is based on how small the theoretical cell size can be. The control of the coverage of small cells is based on technological development.

We assume that the cell can be reduced to a 2-km cell, which means a cell of 2-km radius. A 2-km cell in some areas may cover many highways, and in other areas a 2-km cell may only cover a few highways.

Let a busy traffic area of 12 km radius fit seven 2-km cells. The heaviest traffic cell may cover 4 freeways and 10 heavy traffic streets, as shown in Fig. 2.12. A total length of 64 km of 2 eight-lane freeways, 48 km of 2 six-lane freeways, and 588 km of 43 four-lane roads, including the 10 major roads, are obtained from Fig. 2.12. Assume that the average spacing between cars is 10 m during busy periods. We can determine that the total number of cars is about 70,000. If one-half the cars have car phones, and among them eight-tenths will make a call ($\eta_c = 0.8$) during the busy hour, there are 28,000 calls per hour, based on an average of one call per car if that car phone is used.

The maximum predicted number of calls per hour per a 2-km cell Q is derived from the above scenario. It may be an unrealistic case. However, it demonstrates how we can calculate Q for different scenarios and apply this method to finding the different Q in different geographic areas.

2.4.3 Maximum Number of Frequency Channels Per Cell

The maximum number of frequency channels per cell N is closely related to an average calling time in the system. The standard user's calling habits may change as a result of the charging rate of the system and the general income profile of the users. If an average calling time T is 1.76 min and the maximum calls per hour per cell Q_i is obtained from Sec. 2.4.2,

$$A = \frac{Q_i T}{60} \quad \text{erlangs}$$

then the offered load can be derived as

Assume that the blocking probability is given (see Appendix A), then we can easily find the required number of radios in each cell.15

2.5 CONCEPT OF FREQUENCY REUSE CHANNELS

A radio channel consists of a pair of frequencies, one for each direction of transmission that is used for full-duplex operation. A particular radio channel, say F_1 , used in one geographic zone as named it a cell, say C_1 , with a coverage radius R can be used in another cell with the same coverage radius at a distance D away.

Frequency reuse is the core concept of the cellular mobile radio system. In this frequency reuse system, users in different geographic locations (different cells) may simultaneously use the same frequency channel (see Fig. 2.13). The frequency reuse system can drastically increase the spectrum efficiency, but if the system is not properly designed, serious interference may occur. Interference due to the common use of the same channel is called *cochannel interference* and is our major concern in the concept of frequency reuse.

2.5.1 Frequency Reuse Schemes

The frequency reuse concept can be used in the time domain and the space domain. Frequency reuse in the time domain results in the occupation of the same frequency in different time slots. It is called *time-division multiplexing* (TDM). Frequency reuse in the space domain can be divided into two categories.

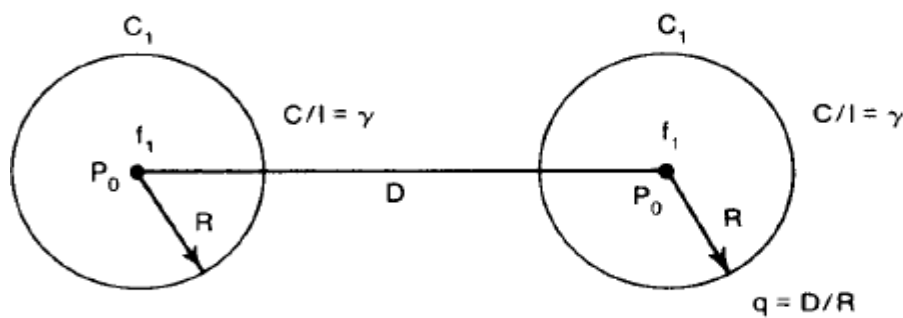

FIGURE 2.13 The ratio of D/R .

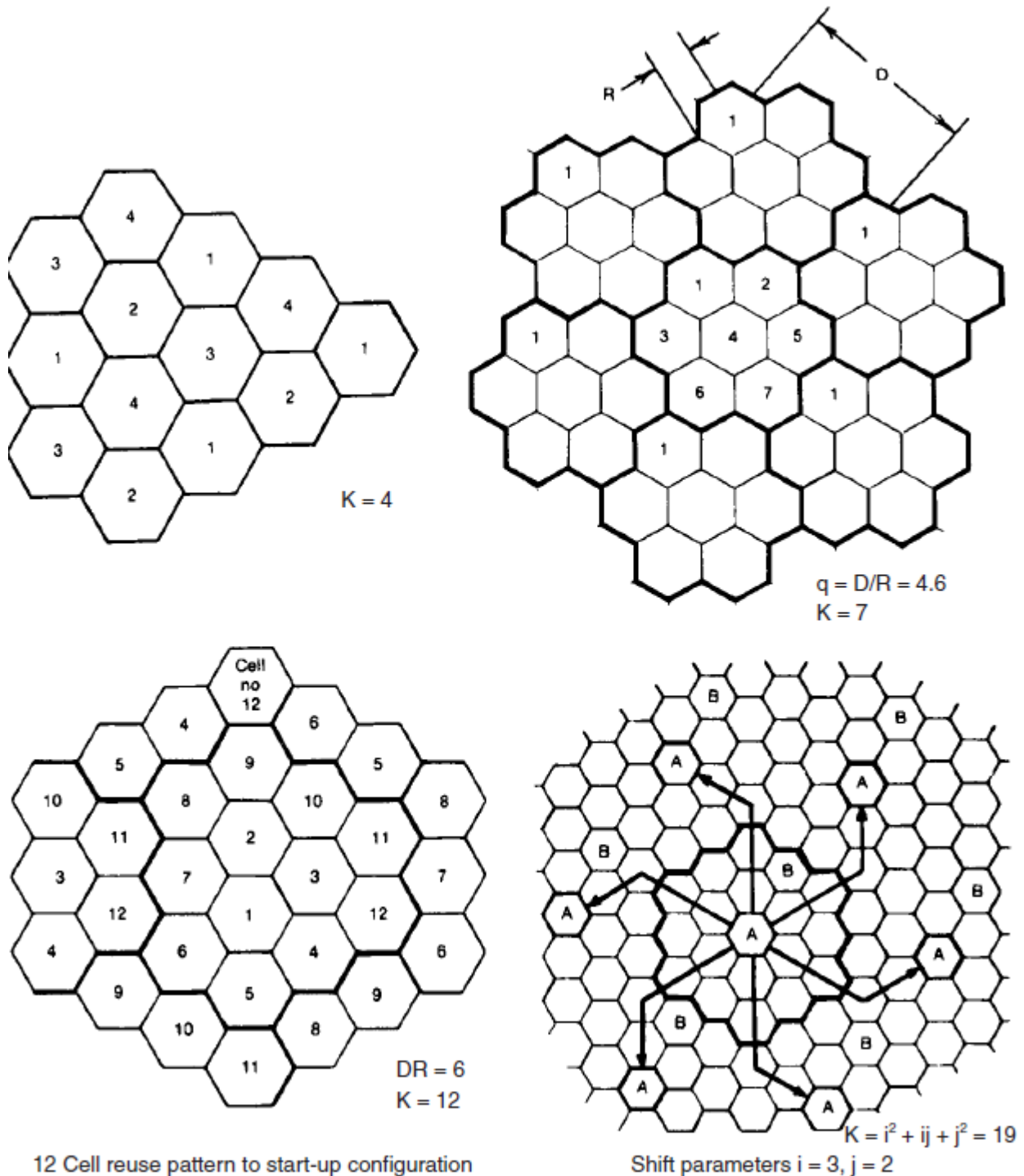

FIGURE 2.14 N -cell reuse pattern.

1. Same frequency assigned in two different geographic areas, such as AM or FM radio stations using the same frequency in different cities.

2. Same frequency repeatedly used in a same general area in one system—the scheme is used in cellular systems. There are many cochannel cells in the system. The total frequency spectrum allocation is divided into K frequency reuse patterns, as illustrated in Fig. 2.14 for $K = 4, 7, 12$, and 19 .

2.5.2 Frequency Reuse Distance

The minimum distance that allows the same frequency to be reused will depend on many factors, such as the number of cochannel cells in the vicinity of the center cell, the type of geographic terrain contour, the antenna height, and the transmitted power at each cell site.

The frequency reuse distance D can be determined^{3,16,17} from

$$D = \sqrt{3KR} \quad (2.5-1)$$

Where K is the frequency reuse pattern shown in Fig. 2.13, then

$$D = \begin{cases} 3.46R & K = 4 \\ 4.6R & K = 7 \\ 6R & K = 12 \\ 7.55R & K = 19 \end{cases}$$

If all the cell sites transmit the same power, then K increases and the frequency reuse distance D increases. This increased D reduces the chance that cochannel interference may occur.

Theoretically, a large K is desired. However, the total number of allocated channels is fixed. When K is too large, the number of channels assigned to each of K cells becomes small. It is always true that if the total number of channels in K cells is divided as K increases, trunking inefficiency results.¹⁸ The same principle applies to spectrum inefficiency: if the total number of channels are divided into two network systems serving in the same area, spectrum inefficiency increases.

Now the challenge is to obtain the smallest number K ¹⁷ that can still meet our system performance requirements. This involves estimating cochannel interference and selecting the minimum frequency reuse distance D to reduce cochannel interference. The smallest value of K is $K = 3$, obtained by setting $i = 1, j = 1$ in the equation $K = i^2 + ij + j^2$ (see Fig. 2.14).

2.5.3 Number of Customers in the System

When we design a system, the traffic conditions in the area during a busy hour are some of the parameters that will help determine both the sizes of different cells and the number of channels in them.

The maximum number of calls per hour per cell is driven by the traffic conditions at each particular cell. After the maximum number of frequency channels per cell has been implemented in each cell, then the maximum number of calls per hour can be taken care of in each cell. Now, take the maximum number of calls per hour in each cell Q_i and sum them over all cells. Assume that 60 percent of the car phones will be used during the busy hour, on average, one call per phone ($\eta_c = 0.6$) if that phone is used. The total allowed subscriber traffic Mt can then be obtained.

Co-channel Interference Reduction Factor:

Reusing an identical frequency channel in different cells is limited by cochannel interference between cells, and the cochannel interference can become a major problem. Here we would like to find the minimum frequency reuse distance in order to reduce this cochannel interference.

Assume that the size of all cells is roughly the same. The cell size is determined by the coverage area of the signal strength in each cell. As long as the cell size is fixed, cochannel interference is independent of the transmitted power of each cell. It means that the received threshold level at the mobile unit is adjusted to the size of the cell. Actually, cochannel interference is a function of a parameter q defined as

$$q = \frac{D}{R} \quad (2.6-1)$$

The parameter q is the cochannel interference reduction factor. When the ratio q increases, cochannel interference decreases. Furthermore, the separation D in Eq. (2.6-1) is a function of K_I and C/I ,

$$D = f(K_I, C/I) \quad (2.6-2)$$

where K_I is the number of cochannel interfering cells in the first tier and C/I is the received carrier-to-interference ratio at the desired mobile receiver.³

$$\frac{C}{I} = \frac{C}{\sum_{k=1}^{K_I} I_k} \quad (2.6-3)$$

In a fully equipped hexagonal-shaped cellular system, there are always six cochannel interfering cells in the first tier, as shown in Fig. 2.15; that is, $K_I = 6$. The maximum number of K_I in the first tier can be shown as six (i.e., $2\pi D/D \approx 6$). Cochannel interference can be experienced both at the cell site and at mobile units in the center cell. If the interference is much greater, then the carrier-to-interference ratio C/I at the mobile units caused by the six interfering sites is (on the average) the same as the C/I received at the center cell site caused by interfering mobile units in the six cells. According to both the reciprocity theorem and the statistical summation of radio propagation, the two C/I values can be very close. Assume that the local noise is much less than the interference level and can be neglected. C/I then can be expressed, from Eq. (2.3-4), as

$$\frac{C}{I} = \frac{R^{-\gamma}}{\sum_{k=1}^{K_I} D_k^{-\gamma}} \quad (2.6-4)$$

where γ is a propagation path-loss slope⁵ determined by the actual terrain environment. In a mobile radio medium, γ usually is assumed to be 4 (see Sec. 2.3.1). K_I is the number of cochannel interfering cells and is equal to 6 in a fully developed system, as shown in Fig. 2.15. The six cochannel interfering cells in the second tier cause weaker interference than those in the first tier (see Example 2.6 at the end of Sec. 2.7.1).

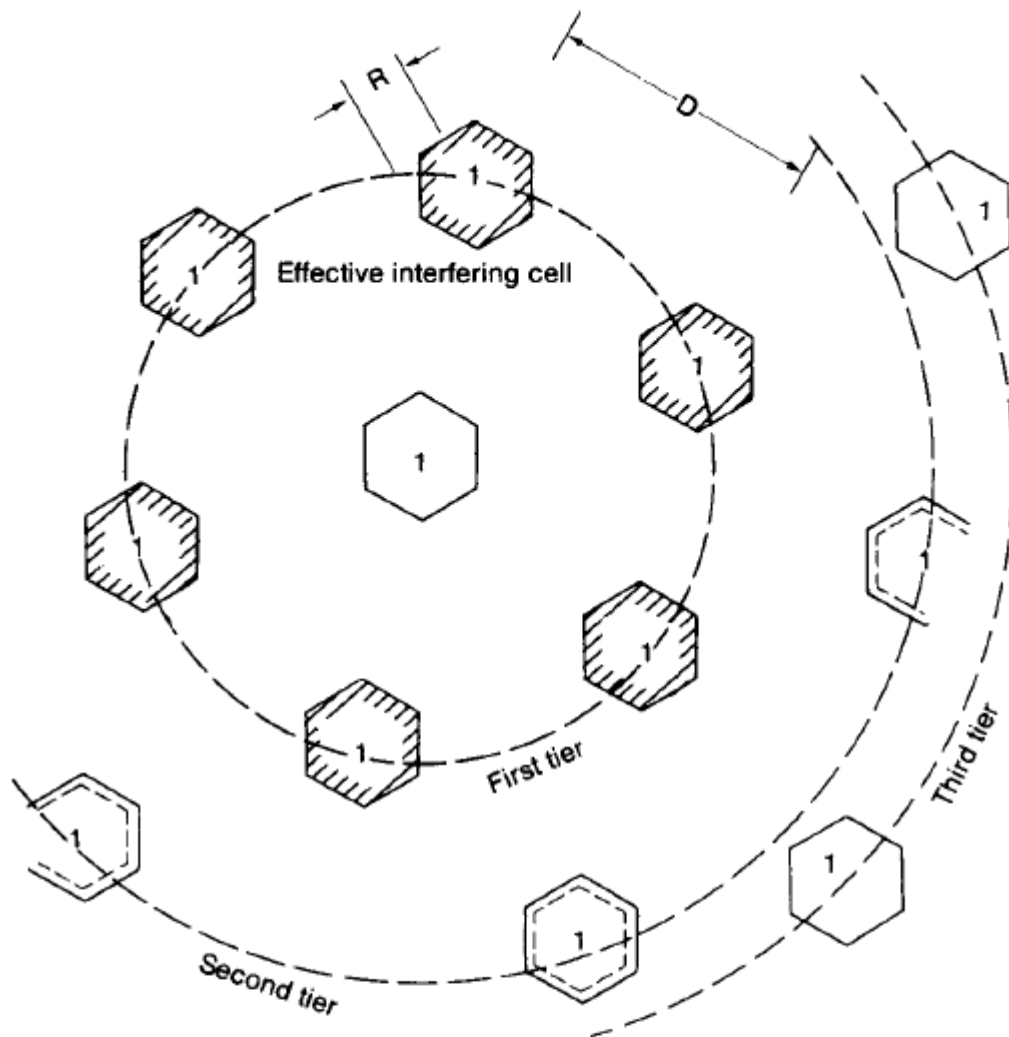

FIGURE 2.15 Six effective interfering cells of cell 1.

Therefore, the cochannel interference from the second tier of interfering cells is negligible. Substituting Eq. (2.6-1) into Eq. (2.6-4) yields

$$\frac{C}{I} = \frac{1}{\sum_{k=1}^{K_I} \left(\frac{D_k}{R}\right)^{-\gamma}} = \frac{1}{\sum_{k=1}^{K_I} (q_k)^{-\gamma}} \quad (2.6-5)$$

where q_k is the cochannel interference reduction factor with k th cochannel interfering cell

$$q_k = \frac{D_k}{R} \quad (2.6-6)$$

desired C/I from a normal case in a omni directional Antenna system

There are two cases to be considered: (1) the signal and cochannel interference received by the mobile unit and (2) the signal and cochannel interference received by the cell site.

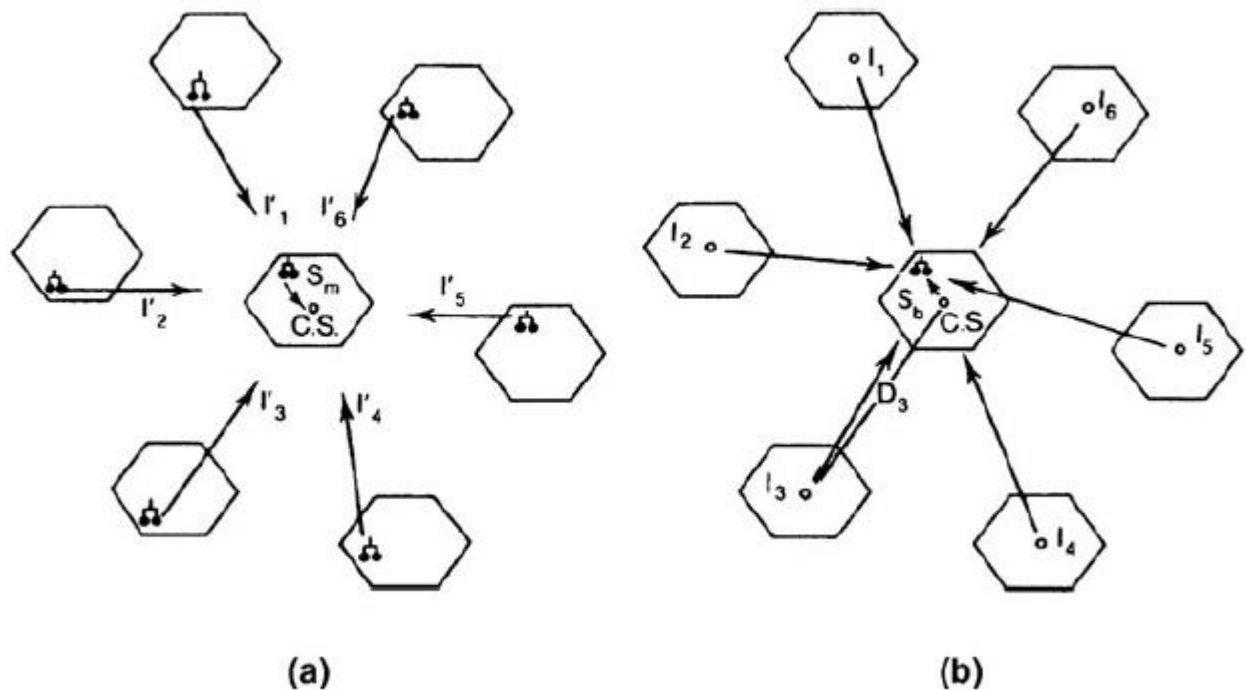

FIGURE 2.16 Cochannel interference from six interferers, (a) Receiving at the cell site; (b) receiving at the mobile unit.

Both cases are shown in Fig. 2.16. N_m , and N_b are the local noises at the mobile unit and the cell site, respectively. Usually, N_m and N_b are small and can be neglected as compared with the interference level. The effect of the cochannel interference on spectrum efficiency systems will appear in Sec. 15.4. As long as the received carrier-to-interference ratios at both the mobile unit and the cell site are the same, the system is called a *balanced system*. In a balanced system, we can choose either one of the two cases to analyze the system requirement; the results from one case are the same for the others.

Assume that all D_k are the same for simplicity, as shown in Fig. 2.15; then $D = D_k$, $q = q_k$, and

$$\frac{C}{I} = \frac{R^{-\gamma}}{6D^{-\gamma}} = \frac{q^\gamma}{6} \quad (2.7-1)$$

Thus
$$q^\gamma = 6 \frac{C}{I} \quad (2.7-2)$$

and
$$q = \left(6 \frac{C}{I}\right)^{1/\gamma} \quad (2.7-3)$$

In Eq. (2.7-3), the value of C/I is based on the required system performance and the specified value of γ is based on the terrain environment. With given values of C/I and γ , the cochannel interference reduction factor q can be determined. Normal cellular practice is to specify C/I to be 18 dB or higher based on subjective tests and the criterion described in Sec. 2.2. Because a C/I of 18 dB is measured by the acceptance of voice quality from present cellular mobile receivers, this acceptance implies that both mobile radio multipath fading and cochannel interference become ineffective at that level. The path-loss slope γ is equal to about 4 in a mobile radio environment.¹⁹

$$q = D/R = (6 \times 63.1)^{1/4} = 4.41 \quad (2.7-4)$$

The 90th percentile of the total covered area would be achieved by increasing the transmitted power at each cell; increasing the same amount of transmitted power in each cell does not affect the result of Eq. (2.7-4). This is because q is not a function of transmitted power. The computer simulation described in the next section finds the value of $q = 4.6$, which is very close to Eq. (2.7-4). The factor q can be related to the finite set of cells K in a hexagonal-shaped cellular system by

$$q = \triangleq \sqrt{3K} \quad (2.7-5)$$

Substituting q from Eq. (2.7-4) into Eq. (2.7-5) yields

$$K = 7 \quad (2.7-6)$$

Equation (2.7-6) indicates that a seven-cell reuse pattern* is needed for a C/I of 18 dB. The seven-cell reuse pattern is shown in Fig. 2.14.

Based on $q = D/R$, the determination of D can be reached by choosing a radius R in Eq. (2.7-4). Usually, a value of q greater than that shown in Eq. (2.7-4) would be desirable. The greater the value of q , the lower the cochannel interference. In a real environment, Eq. (2.6-5) is always true, but Eq. (2.7-1) is not. Because Eq. (2.7-4) is derived from Eq. (2.7-1), the value q may not be large enough to maintain a carrier-to-interference ratio of 18 dB. This is particularly true in the worst case, as shown in Chap. 9.

EXAMPLE 2.6 Compare interference from the first tier of 6 interferers with that from 12 interferers (first and second tiers) (see Fig. 2.15).

From the first tier,

$$\frac{C}{I} = \frac{C}{\sum_{i=1}^6 I_i} = \frac{R_1^{-4}}{6D_1^{-4}} = \frac{a_1^4}{6} \quad (E2.6-1)$$

From the first and second tiers,

$$\frac{C}{I} = \frac{C}{\sum_{i=1}^6 (I_{1i} + I_{2i})} = \frac{1}{6(a_1^{-4} + a_2^{-4})} \quad (E2.6-2)$$

Because we have found $a_1 = 4.6$, then from the second tier, $a_2 = D_2/R_1 = 2D_1/R_1 = 2a_1 = 9.2$. Substituting a_1 and a_2 into Eqs. (E2.6-1) and (E2.6-2), respectively, yields

$$\left(\frac{C}{I}\right)_{\text{1st tier}} = 18.72 \text{ dB}$$

$$\left(\frac{C}{I}\right)_{\text{1st and 2nd tiers}} = 18.46 \text{ dB}$$

We realize that a negligible amount of interference is contributed by the six interferers from the second tier.

Solution Obtained From Simulation

The required cochannel reduction factor q can be obtained from the simulation also. Let one main cell site and all six possible cochannel interferers be deployed in a pattern, as shown in Fig. 2.15. The distance D from the center cell to the cochannel interferers in the simulation is a variable. $D = 2R$ can be used initially and incremented every $0.5R$ as $D = 2R, 2.5R, 3R$. For every particular value of D , a set of simulation data is generated.

First, the location of each mobile unit in its own cell is randomly generated by a random generator. Then the distance D_k from each of the six interfering mobile units to the center cell site (assuming $K_I = 6$) is obtained. The desired mobile signal as well as six interference levels received at the center cell site would be randomly generated following the mobile radio propagation path-loss rule, which is 40 dB/dec, along with a log-normal standard deviation of 8 dB at its mean value.²⁰ Summing up all the data from six simulated interferences,

$$I = \sum_{k=1}^{K_I-6} -I_k$$

and dividing it by the simulated main carrier, value C becomes C/I .

This C/I is for a particular D , the distance between the center cell site and the cochannel cell sites (cochannel interferers). Repeat this process, say 1000 times, for each particular value of D , based on the criterion stated in Sec. 2.2.4 (that 75 percent of the users say voice quality is “good” or “excellent” in 90 percent of the total covered area). Then from 75 percent of the users’ opinion, $C/I = 18$ dB needs to be achieved¹⁸ with a proper value of D . Assuming that mobile unit locations are chosen randomly and uniformly, then 90 percent of the area corresponds to 900 out of 1000 mobile unit locations.

To find a proper value for D , each mobile unit location associates with its received C/I . Some C/I values are high and some are low. This means that the lowest 100 values of C/I should be discarded. The main C/I value should be derived from the remaining 900 C/I values. This associates a particular C/I for a particular separation D . Repeating this process for different values of D , the corresponding mean C/I values are found. The C/I versus D curve can be plotted, depicting $C/I = 18$ dB as corresponding to $D = 4.6R$, as illustrated in the Bell Lab publication.⁴ Then

$$q = \frac{D}{R} = 4.6 \quad (2.7-7)$$

Comparing the values of q obtained from an analytic solution shown in Eq. (2.7-4) and q obtained from a simulation solution shown in Eq. (2.7-7), the results are surprisingly close.

Although a simulation (statistical) approach deals with a real-world situation, it does not provide a clear physical picture. The two agreeable solutions illustrated in this section prove that the simple analytic method is implementable in a cellular system based on hexagonal cells.

HANDOFF MECHANISM:

The handoff is the process mentioned in Sec. 2.4.1. It is a unique feature that allows cellular systems to operate as effectively as demonstrated in actual use. There are two kinds of handoffs, hard and soft. The hard handoff is “brake before make.” The soft handoff is “make before brake.” To clearly describe the hard handoff concept, it is easy to use a one-dimensional illustration as shown in Fig. 2.17, although a real two-dimensional cellular configuration would cover an area with cells. The hard handoff concept as applied to a one-dimensional case will also apply to two-dimensional cases.

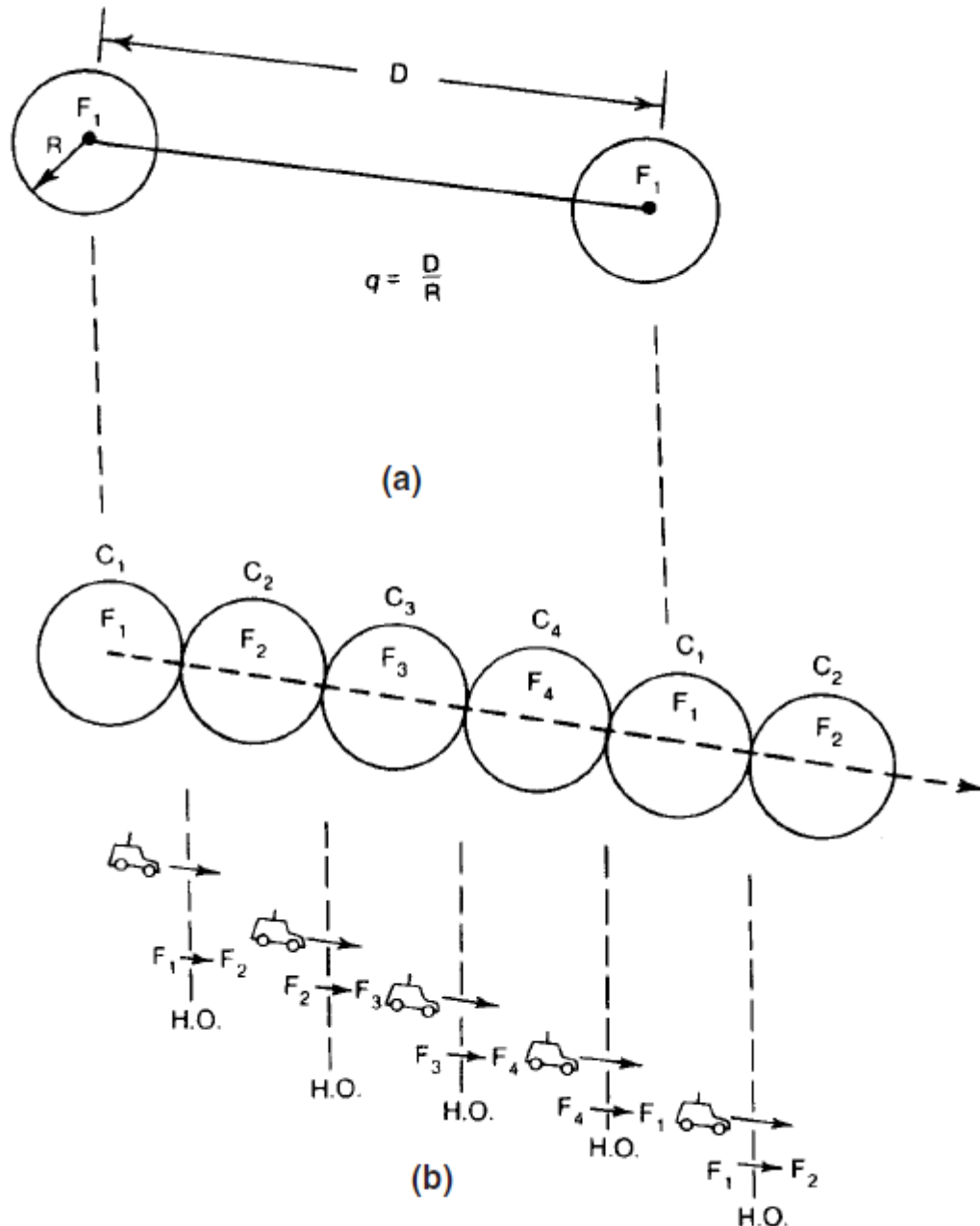

FIGURE 2.17 Handoff mechanism. (a) Cochannel interference reduction ratio q . (b) Fill-in frequencies.

Two cochannel cells using the frequency F_1 separated by a distance D are shown in Fig. 2.17a. The radius R and the distance D are governed by the value of q . Now we have to fill in with other frequency channels such as F_2 , F_3 , and F_4 between two cochannel cells in order to provide a communication system in the whole area. The fill-in frequencies F_2 , F_3 , and F_4 are also assigned to their corresponding cells C_2 ,

$C3$, and $C4$ (see Fig. 2.17b) according to the same value of q .

Suppose a mobile unit is starting a call in cell $C1$ and then moves to $C2$. The call can be dropped and reinitiated in the frequency channel from $F1$ to $F2$ while the mobile unit moves from cell $C1$ to cell $C2$. This process of changing frequencies can be done automatically by the system without the user's intervention. This process of hard handoff is carried on in the cellular system, for FDMA and TDMA systems.

The soft handoff is used in CDMA systems. Because in CDMA, $K = 1$, the soft handoff is carried out when the mobile enters the neighboring cell. In the overlapped area between two cells, two traffic channels, one from each cell, serve one mobile call during the soft handoff.

The handoff processing scheme is an important task for any successful mobile system. How does one make any one of the necessary handoffs successful? How does one reduce all unnecessary handoffs in the system? How is the individual cell traffic capacity controlled by altering the handoff algorithm?

Cell splitting, consideration of the components of Cellular system.

2.9.1 Why Splitting?

The motivation behind implementing a cellular mobile system is to improve the utilization of spectrum efficiency.¹⁹ The frequency reuse scheme is one concept, and cell splitting is another concept. When traffic density starts to build up and the frequency channels F_i in each cell C_i cannot provide enough mobile calls, the original cell can be split into smaller cells. Usually the new radius is one-half the original radius (see Fig. 2.18). There are two ways of splitting. In Fig. 2.18a, the original cell site is not used, while in Fig. 2.18b, it is.

$$\text{New cell radius} = \frac{\text{old cell radius}}{2} \quad (2.9-1)$$

Then, based on Eq. (2.9-1), the following equation is true.

$$\text{New cell area} = \frac{\text{old cell area}}{4} \quad (2.9-2)$$

Let each new cell carry the same maximum traffic load of the old cell; then, in theory,

$$\frac{\text{New traffic load}}{\text{Unit area}} = 4 \times \frac{\text{traffic load}}{\text{unit area}}$$

2.9.2 How Splitting?

There are two kinds of cell-splitting techniques:

1. *Permanent splitting*. The installation of every new split cell has to be planned ahead of time; the number of channels, the transmitted power, the assigned frequencies, the choosing of the cell-site selection, and the traffic load consideration should all be considered. When ready, the actual service cut-over should be set at the lowest traffic point, usually at midnight on a weekend. Hopefully, only a few calls will be dropped because of this cut-over, assuming that the downtime of the system is within 2 h.
 2. *Dynamic splitting*. This scheme is based on using the allocated spectrum efficiency in real time. The algorithm for dynamically splitting cell sites is a tedious job, as we cannot
-

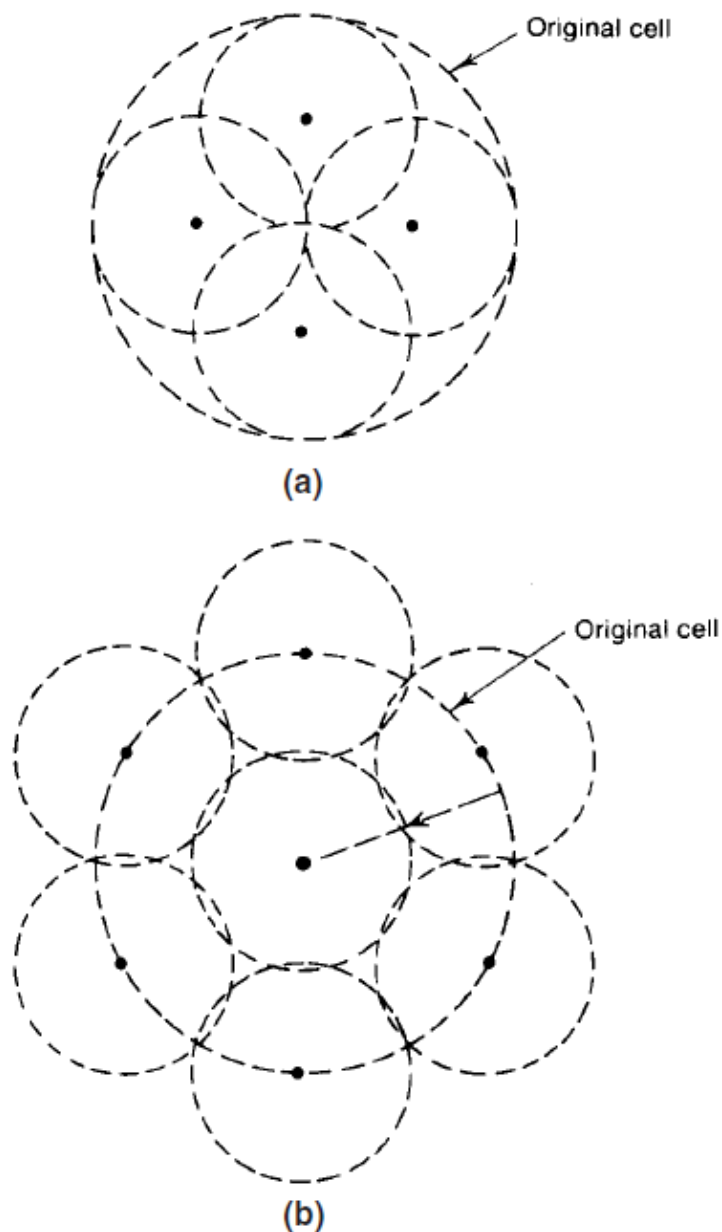

FIGURE 2.18 Cell splitting.

afford to have one single cell unused during cell splitting at heavy traffic hours. Section 12.6.2 will discuss this topic in depth.

CONSIDERATION OF THE COMPONENTS OF CELLULAR SYSTEMS

The elements of cellular mobile radio system design have been mentioned in the previous sections. Here we must also consider the components of cellular systems, such as mobile radios, antennas, cell-site, base-station controller, and MTSO. They would affect our system design if we do not choose the right one. The general view of the cellular system is shown in Fig. 2.19. Even though the EIA (Electronic Industries Association) and the FCC have specified standards for radio equipment at the cell sites and the mobile sites, we still need

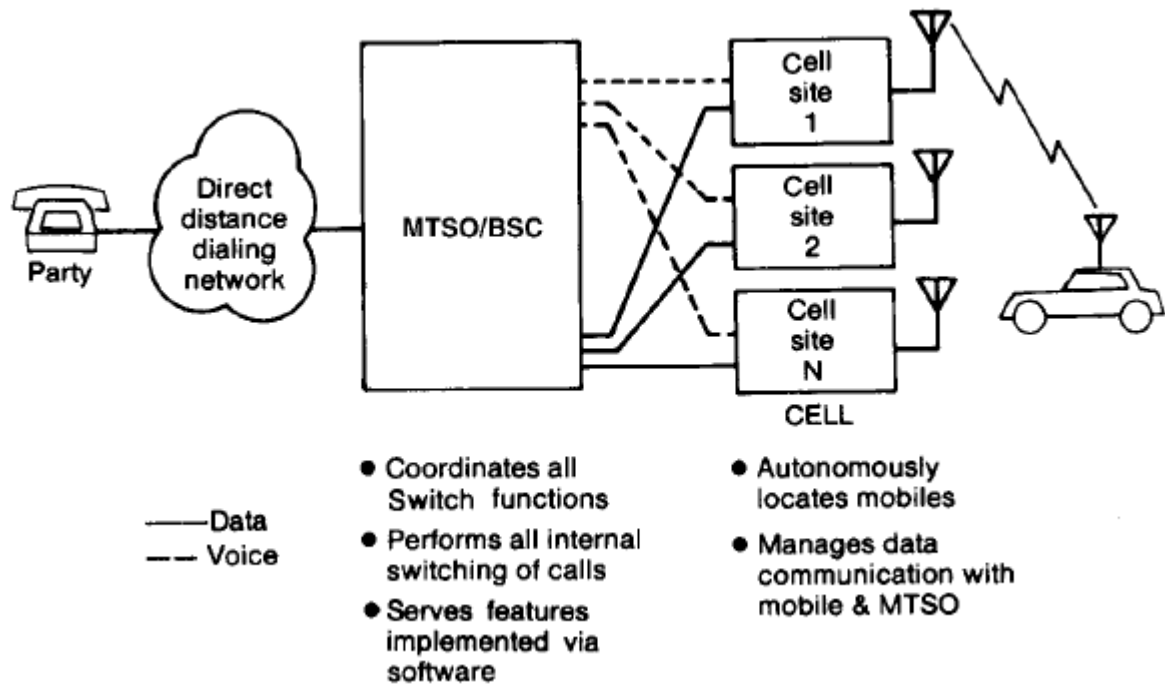

FIGURE 2.19 A general view of cellular telecommunications systems.

to be concerned about that equipment. The issues affecting choice of antennas, switching equipment, and data links are briefly described here.^{21–23}

Antennas

Antenna pattern, antenna gain, antenna tilting, and antenna height⁶ all affect the cellular system design. The antenna pattern can be omnidirectional, directional, or any shape in both the vertical and the horizon planes. Antenna gain compensates for the transmitted power. Different antenna patterns and antenna gains at the cell site and at the mobile units would affect the system performance and so must be considered in the system design.

The antenna patterns seen in cellular systems are different from the patterns seen in free space. If a mobile unit travels around a cell site in areas with many buildings, the omnidirectional antenna will not duplicate the omnipattern. In addition, if the front-to-back ratio of a directional antenna is found to be 20 dB in free space, it will be only 10 dB at the cell site. An explanation for these phenomena is given in Chapter 8.

Antenna tilting can reduce the interference to the neighboring cells and enhance the weak spots in the cell. Also, the height of the cell-site antenna can affect the area and shape of the coverage in the system. The effect of antenna height will be described in Chap. 8.

Switching Equipment

The capacity of switching equipment in cellular systems is not based on the number of switch ports but on the capacity of the processor associated with the switches. In a big cellular system, this processor should be large. Also, because cellular systems are unlike other systems, it is important to consider when the switching equipment would reach the maximum capacity.

The service life of the switching equipment is not determined by the life cycle of the equipment but by how long it takes to reach its full capacity. If the switching equipment is designed in modules, or as distributed switches, more modules can be added to increase the capacity of the equipment. For decentralized systems, digital switches may be more

suitable. The future trend seems to be the utilization of system handoff. This means that switching equipment can link to other switching equipment so that a call can be carried from one system to another system without the call being dropped. We will discuss these issues in Chap. 13.

Data Links

The data links are shown in Fig. 2.19. Although they are not directly affected by the cellular system, they are important in the system. Each data link can carry multiple channel data (10 kbps data transmitted per channel) from the cell site to the MTSO. This fast-speed data transmission cannot be passed through a regular telephone line. Therefore, data bank devices are needed. They can be multiplexed, many-data channels passing through a wideband T-carrier wire line or going through a microwave radio link where the frequency is much higher than 850 MHz.

Module-III

INTERFERENCE : Introduction to Co-Channel Interference

The cochannel interference is usually involved with FDMA, TDMA, and OFDMA systems. The interference occurred because the frequency reuse scheme is applied to those systems in which the channels operate at the same frequency but repeatedly in separate locations. If the specified separation is large, the cochannel interference is reduced, but the number of the cochannel in a given area is also reduced. As a result, the capacity is reduced. Therefore, we have to find an optimal separation from which the reduction level of cochannel interference is acceptable and the capacity reaches to a maximum.

In a single-carrier CDMA system, every cell uses the same CDMA frequency carrier, and within the carrier, using different spreading codes creates the number of traffic channels. Therefore, there is no cochannel interference in CDMA but code channel interference among the traffic channels. For reducing the code channel interference, the power control is a very critical element.

The frequency-reuse method is useful for increasing the efficiency of spectrum usage but results in cochannel interference because the same frequency channel is used repeatedly in different cochannel cells. Application of the cochannel interference reduction factor $q = D/R = 4.6$ for a seven-cell reuse pattern ($K = 7$) is described in Sec.2.7.1

The cochannel interference reduction factor $q = 4.6$ is based on the system required $C/I = 18$ dB of the AMPS system. From $q = 4.6$ we can obtain $K = 7$. Nevertheless, the system required C/I is different from a different system. For those systems with lower required C/I levels, the q values are less.

In this chapter, we try to use the AMPS system as an example to illustrate the ways of reducing cochannel interference. For other FDMA, TDMA, and OFDMA systems, the same methodology is applied.

In most mobile radio environments, use of a seven-cell reuse pattern is not sufficient to avoid cochannel interference for AMPS systems. Increasing $K > 7$ would reduce the number of cochannels per cell, and that would also reduce spectrum efficiency. Therefore, it might be advisable to retain the same number of radios as the seven-cell system but to sector the cell radially, as if slicing a pie. This technique would reduce cochannel interference and use channel sharing and channel borrowing schemes to increase spectrum efficiency.

Find the Cochannel Interference Area Which Affects a Cell Site:

Cochannel interference that occurs in one channel will occur equally in all the other channels in a given area. We can then measure cochannel interference by selecting any one channel (as one channel represents all the channels) and transmitting on that channel at all cochannel sites at night while the mobile receiver is traveling in one of the cochannel cells.

While performing this test, we watch for any change detected by a field-strength recorder in the mobile unit and compare the data with the condition of no cochannel sites being transmitted. This test must be repeated as the mobile unit travels in every cochannel cell. To facilitate this test, we can install a channel scanning receiver in one car.

One channel (f_1) records the signal level (no-cochannel condition), another channel (f_2) records the interference level (six-cochannel condition is the maximum), while the third channel receives f_2 , which is not transmitting in the air. Therefore, the noise level is recorded only in f_3 (see Fig. 9.1).

We can obtain, in decibels, the carrier-to-interference ratio C/I by subtracting the result obtained from f_3 from the result obtained from f_1 (carrier minus interference $C - I$) and the carrier-to-noise ratio C/N by subtracting the result obtained from f_3 from the result obtained from f_2 (carrier minus noise $C - N$). Four conditions should be used to compare the results.

1. If the carrier-to-interference ratio C/I is greater than 18 dB throughout most of the cell, the system is properly designed for capacity.
2. If C/I is less than 18 dB and C/N is greater than 18 dB in some areas, there is cochannel

interference.

3. If both C/N and C/I are less than 18 dB and $C/N = C/I$ in a given area, there is a coverage problem.

4. If both C/N and C/I are less than 18 dB and $C/N > C/I$ in a given area, there is a coverage problem *and* cochannel interference.

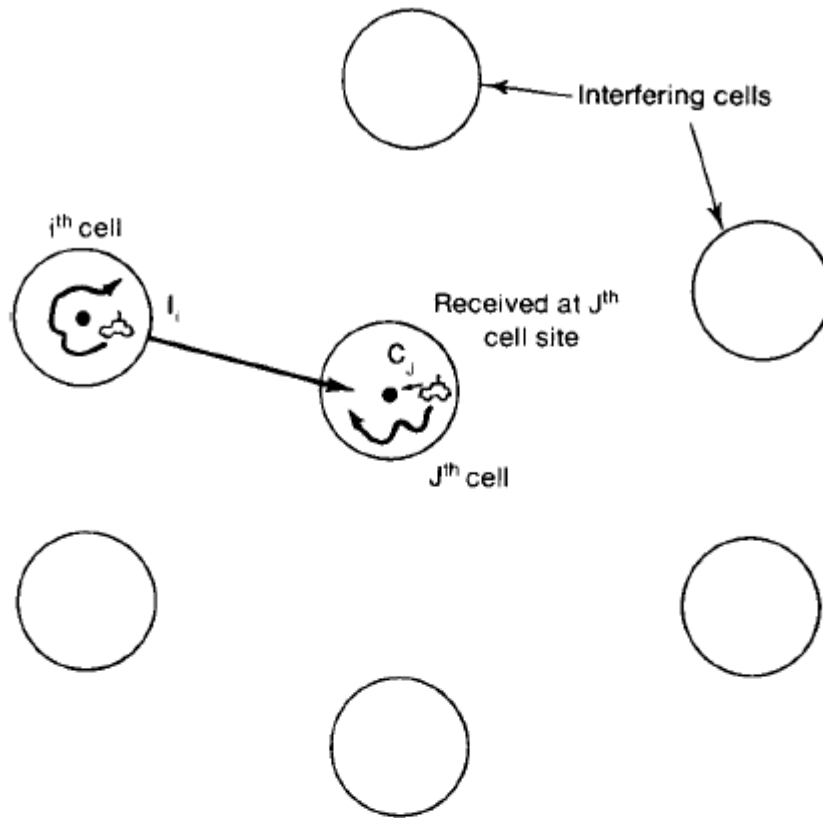

FIGURE 9.2 Test 2: cochannel interference at the cell site.

$$\frac{C_J}{I} = \frac{C_J}{\sum_{\substack{i=1 \\ i \neq J}}^6 I_i}$$

The number of cochannel cells in the system can be less than six. We must be aware that all C_J and I_i were read in decibels. Therefore, a translation from decibels to linear is needed before summing all the interfering sources. The test can be carried out repeatedly for any given cell. We then compare

$$\frac{C_J}{I} \quad \text{and} \quad \frac{C_J}{N_J}$$

and determine the cochannel interference condition, which will be the same as that in test 1. N_J is the noise level in the J th cell assuming no interference exists.

MEASUREMENT AT MOBILE RADIO TRANSCIVERS

When the carriers are angularly modulated by the voice signal and the RF frequency difference between them is much higher than the fading frequency, measurement of the signal carrier-to-interference ratio C/I reveals that the signal is

$$e_1 = S(t) \sin(\omega t + \phi_1)$$

and the interference is

$$e_2 = I(t) \sin(\omega t + \phi_2) \quad (9.3-2)$$

The received signal is

$$e(t) = e_1(t) + e_2(t) = R \sin(\omega t + \psi) \quad (9.3-3)$$

where

$$R = \sqrt{[S(t) \cos \phi_1 + I(t) \cos \phi_2]^2 + [S(t) \sin \phi_1 + I(t) \sin \phi_2]^2} \quad (9.3-4)$$

and

$$\psi = \tan^{-1} \frac{S(t) \sin \phi_1 + I(t) \sin \phi_2}{S(t) \cos \phi_1 + I(t) \cos \phi_2} \quad (9.3-5)$$

The envelope R can be simplified in Eq. (9.3-4), and R^2 becomes

$$R^2 = [S^2(t) + I^2(t) + 2S(t)I(t) \cos(\phi_1 - \phi_2)] \quad (9.3-6)$$

Following Kozono and Sakamoto's² analysis of Eq. (9.3-6), the term $S^2(t) + I^2(t)$ fluctuates close to the fading frequency V/λ and the term $2S(t)I(t) \cos(\phi_1 - \phi_2)$ fluctuates to a frequency close to $d/dt(\phi_1 - \phi_2)$, which is much higher than the fading frequency. Then the two parts of the squared envelope can be separated as

$$X = S^2(t) + I^2(t) \quad (9.3-7)$$

$$Y = 2S(t)I(t) \cos(\phi_1 - \phi_2) \quad (9.3-8)$$

Assume that the random variables $S(t)$, $I(t)$, ϕ_1 , and ϕ_2 are independent; then the average processes on X and Y are

$$\bar{X} = \overline{S^2(t)} + \overline{I^2(t)} \quad (9.3-9)$$

$$\bar{Y}^2 = 4\overline{S^2(t)I^2(t)}(\frac{1}{2}) = 2\overline{S^2(t)I^2(t)} \quad (9.3-10)$$

The signal-to-interference ratio Γ becomes

$$\Gamma = \frac{\overline{S^2(t)}}{\overline{I^2(t)}} = k + \sqrt{k^2 - 1} \quad (9.3-11)$$

where

$$k = \frac{\bar{X}}{\bar{Y}^2} - 1 \quad (9.3-12)$$

Because X and Y can be separated in Eq. (9.3-6), the preceding computation of Γ in Eq. (9.3-11) could have been accomplished by means of an envelope detector, analog-to-digital converter, and a microcomputer. The sampling delay time Δt should be small enough to satisfy

$$S(t) \approx S(t + \Delta t), \quad I(t) \approx I(t + \Delta t) \quad (9.3-13)$$

and

$$E[\cos[\phi_1(t) - \phi_2(t)] \cos[\phi_1(t + \Delta t) - \phi_2(t + \Delta t)]] \approx 0 \quad (9.3-14)$$

Determining the delay time Δt to meet the requirement of Eq. (9.3-13) for this calculation is difficult and is a drawback to this measurement technique. Therefore, real-time cochannel interference measurement is difficult to achieve in practice.

design of Antenna system & Antenna parameters and their effects

In Sec. 2.7, we proved that the value of $q = 4.6$ is valid for a normal interference case in a $K = 7$ cell pattern.³ In this section, we would like to prove that a $K = 7$ cell pattern does not provide a sufficient frequency-reuse distance separation even when an ideal condition of flat terrain is assumed. The worst case is at the location where the mobile unit would receive the weakest signal from its own cell site but strong interferences from all interfering cell sites.

In the worst case the mobile unit is at the cell boundary R , as shown in Fig. 9.3. The distances from all six cochannel interfering sites are also shown in the figure: two distances of $D - R$, two distances of D , and two distances of $D + R$.

FIGURE 9.3

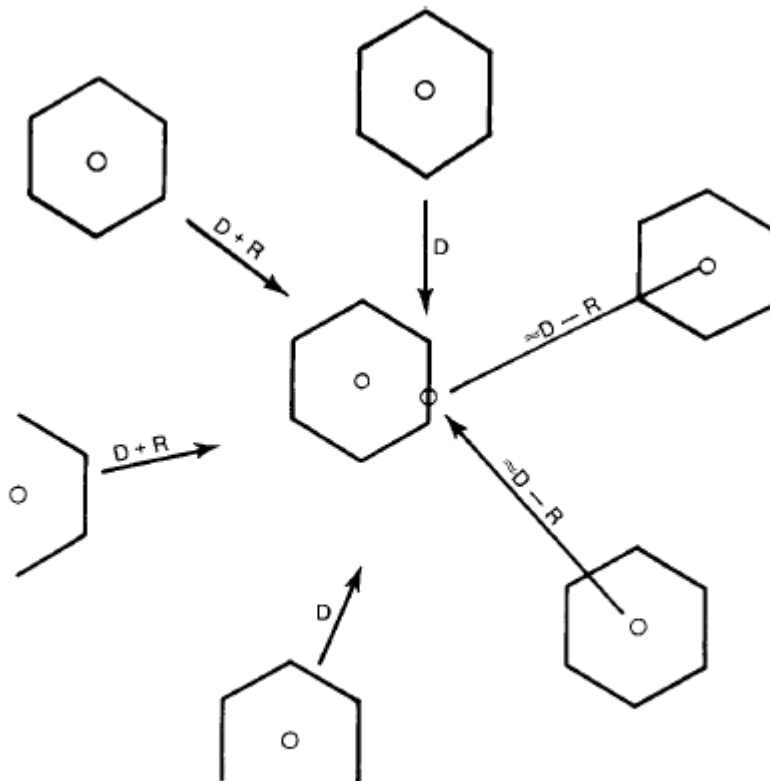

FIGURE 9.3 Cochannel interference (a worst case).

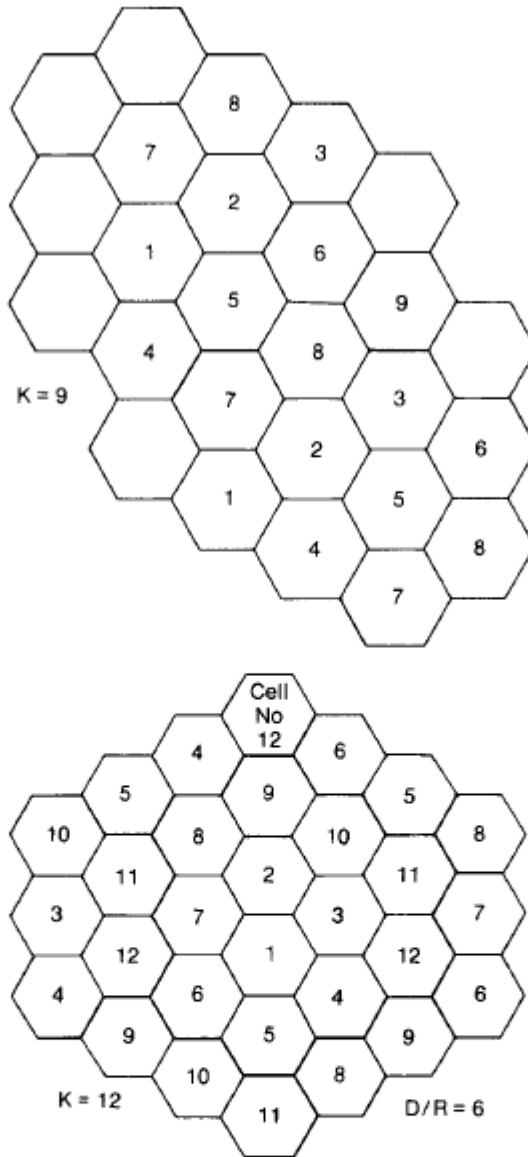

FIGURE 9.4 Interference with frequency-reuse patterns $K = 9$ and $K = 12$.

Following the mobile radio propagation rule of 40 dB/dec shown in Sec. 2.3, we obtain

$$C \propto R^{-4} \quad I \propto D^{-4}$$

Then the carrier-to-interference ratio is

$$\begin{aligned} \frac{C}{I} &= \frac{R^{-4}}{2(D-R)^{-4} + 2(D)^{-4} + 2(D+R)^{-4}} \\ &= \frac{1}{2(q-1)^{-4} + 2(q)^{-4} + 2(q+1)^{-4}} \end{aligned} \quad (9.4-1a)$$

where $q = 4.6$ is derived from the normal case shown in Eq. (2.7-7). Substituting $q = 4.6$ into Eq. (9.4-1a), we obtain $C/I = 54$ or 17 dB, which is lower than 18 dB. To be conservative, we may use the shortest distance $D - R$ for all six interferers as a worst case; then Eq. (9.4-1a) is replaced by

$$\frac{C}{I} = \frac{R^{-4}}{6(D - R)^{-4}} = \frac{1}{6(q - 1)^{-4}} = 28 = 14.47 \text{ dB} \quad (9.4-1b)$$

In reality, because of the imperfect site locations and the rolling nature of the terrain configuration, the C/I received is always worse than 17 dB and could be 14 dB and lower. Such an instance can easily occur in a heavy traffic situation; therefore, the system must be designed around the C/I of the worst case. In that case, a cochannel interference reduction factor of $q = 4.6$ is insufficient.

Therefore, in an omnidirectional-cell system, $K = 9$ or $K = 12$ would be a correct choice. Then the values of q are

$$q = \begin{cases} \frac{D}{R} = \sqrt{3K} \\ 5.2 & K = 9 \\ 6 & K = 12 \end{cases} \quad (9.4-2)$$

Substituting these values in Eq. (9.4-1), we obtain

$$\frac{C}{I} = 84.5 (=) 19.25 \text{ dB} \quad K = 9 \quad (9.4-3)$$

$$\frac{C}{I} = 179.33 (=) 22.54 \text{ dB} \quad K = 12 \quad (9.4-4)$$

The $K = 9$ and $K = 12$ cell patterns, shown in Fig. 9.4, are used when the traffic is light. Each cell covers an adequate area with adequate numbers of channels to handle the traffic.

9.5 DESIGN OF A DIRECTIONAL ANTENNA SYSTEM

When the call traffic begins to increase, we need to use the frequency spectrum efficiently and avoid increasing the number of cells K in a seven-cell frequency-reuse pattern. When K increases, the number of frequency channels assigned in a cell must become smaller (assuming a total allocated channel divided by K) and the efficiency of applying the frequency-reuse scheme decreases.

Instead of increasing the number K in a set of cells, let us keep $K = 7$ and introduce a directional-antenna arrangement. The cochannel interference can be reduced by using directional antennas. This means that each cell is divided into three or six sectors and uses three or six directional antennas at a base station. Each sector is assigned a set of frequencies (channels). The interference between two cochannel cells decreases as shown Fig. 9.5.

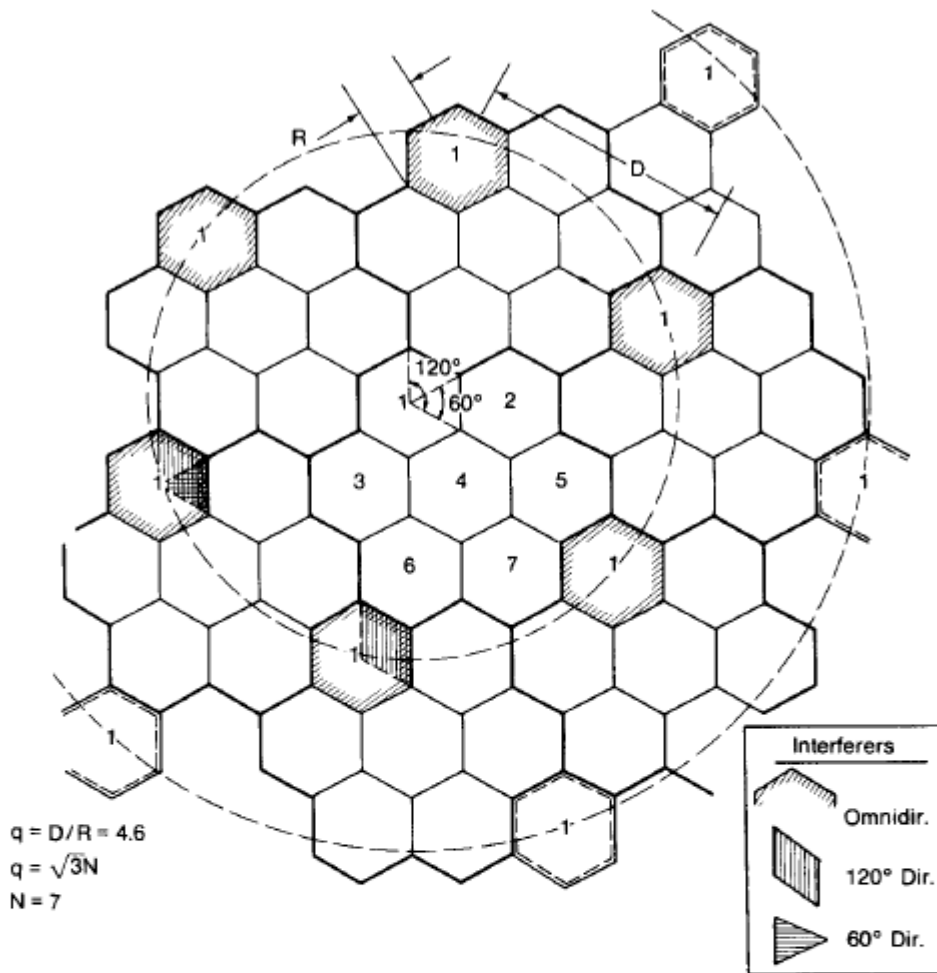

FIGURE 9.5 Interfering cells shown in a seven-cell system (two-tiers).

9.5.1 Directional Antennas In $K = 7$ Cell Patterns

9.5.1.1 Three-Sector Case. The three-sector case is shown in Fig. 9.5. To illustrate the worst-case situation, two cochannel cells are shown in Fig. 9.6a. The mobile unit at position *E* will experience greater interference in the lower shaded cell sector than in the upper shaded cell-sector site. This is because the mobile receiver receives the weakest signal from its own cell but fairly strong interference from the interfering cell. In a three-sector case, the interference is effective in only one direction because the front-to-back ratio of a cell-site directional antenna is at least 10 dB or more in a mobile radio environment. The worst-case cochannel interference in the directional-antenna sectors in which interference occurs may be calculated. Because of the use of directional antennas, the number of principal interferers is reduced from six to two (Fig. 9.5). The worst case of *C/I* occurs when the mobile unit is at position *E*, at which point the distance between the mobile unit and the two interfering antennas is roughly $D + (R/2)$; however, *C/I* can be calculated more precisely as follows.*

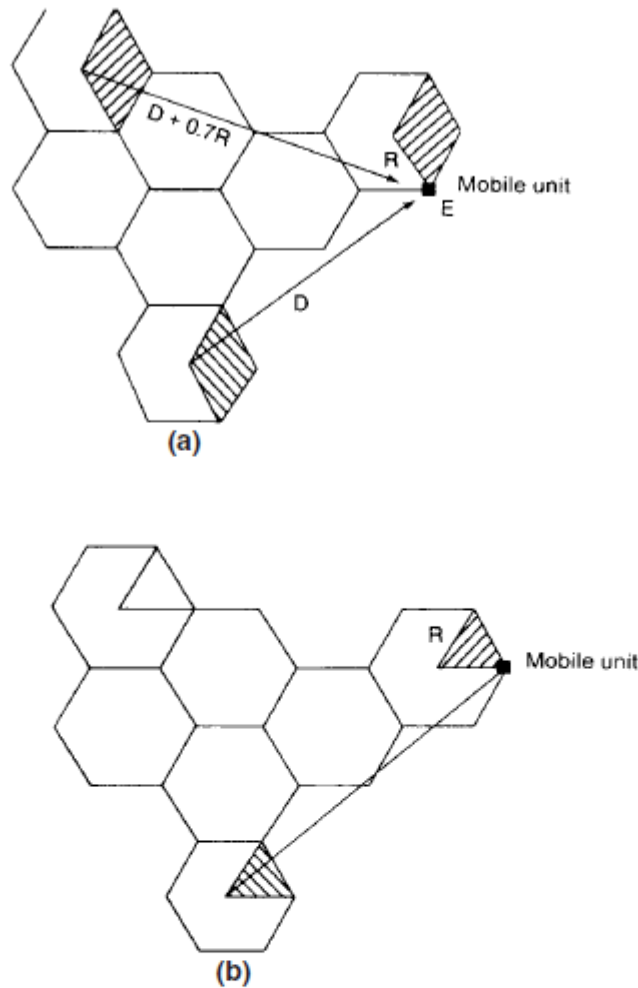

FIGURE 9.6 Determination of carrier-to-interference ratio C/I in a directional antenna system. (a) Worst case in a 120° directional antenna system ($N = 7$); (b) worst case in a 60° directional antenna system ($N = 7$).

The value of C/I can be obtained by the following expression (assuming that the worst case is at position E at which the distances from two interferers are $D + 0.7R$ and D).

$$\begin{aligned} \frac{C}{I}(\text{worst case}) &= \frac{R^{-4}}{(D + 0.7R)^{-4} + D^{-4}} \\ &= \frac{1}{(q + 0.7)^{-4} + q^{-4}} \end{aligned} \quad (9.5-1)$$

Let $q = 4.6$; then Eq. (9.5-1) becomes

$$\frac{C}{I}(\text{worst case}) = 285 (=) 24.5 \text{ dB} \quad (9.5-2)$$

The C/I received by a mobile unit from the 120° directional antenna sector system expressed in Eq. (9.5-2) greatly exceeds 18 dB in a worst case. Equation (9.5-2) shows that using directional antenna sectors can improve the signal-to-interference ratio, that is, reduce the cochannel interference. However, in reality, the C/I could be 6 dB weaker than in Eq. (9.5-2) in a heavy traffic area as a result of irregular terrain contour and imperfect site locations. The remaining 18.5 dB is still adequate.

9.5.1.2 Six-Sector Case. We may also divide a cell into six sectors by using six 60° -beam directional antennas as shown in Fig. 9.6b. In this case, only one instance of interference can occur in each sector as shown in Fig. 9.5. Therefore, the carrier-to-interference ratio in this case is

$$\frac{C}{I} = \frac{R^{-4}}{(D + 0.7R)^{-4}} = (q + 0.7)^4 \quad (9.5-3)$$

For $q = 4.6$, Eq. (9.5-3) becomes

$$\frac{C}{I} = 794 (=) 29 \text{ dB} \quad (9.5-4)$$

which shows a further reduction of cochannel interference. If we use the same argument as we did for Eq. (9.5-2) and subtract 6 dB from the result of Eq. (9.5-4), the remaining 23 dB is still more than adequate. When heavy traffic occurs, the 60° -sector configuration can be used to reduce cochannel interference. However, fewer channels are generally allowed in a 60° sector and the trunking efficiency decreases. In certain cases, more available channels could be assigned in a 60° sector.

9.5.2 Directional Antenna in $K = 4$ Cell Pattern

9.5.2.1 Three-Sector Case. To obtain the carrier-to-interference ratio, we use the same procedure as in the $K = 7$ cell-pattern system. The 120° directional antennas used in the sectors reduced the interferers to two as in $K = 7$ systems, as shown in Fig. 9.7. We can apply Eq. (9.5-1) here. For $K = 4$, the value of $q = \sqrt{3K} = 3.46$; therefore, Eq. (9.5-1) becomes

$$\frac{C}{I} \text{ (worst case)} = \frac{1}{(q + 0.7)^{-4} + q^{-4}} = 97 = 20 \text{ dB} \quad (9.5-5)$$

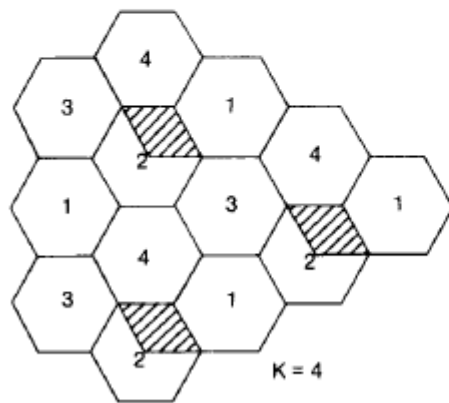

FIGURE 9.7 Interference with frequency-reuse pattern $K = 4$.

If, using the same reasoning used with Eq. (9.5-4), 6 dB is subtracted from the result of Eq. (9.5-5), the remaining 14 dB is unacceptable.

9.5.2.2 Six-Sector Case. There is only one interferer at a distance of $D + R$ shown in Fig. 9.7. With $q = 3.46$, we can obtain

$$\frac{C}{I} \text{ (worst case)} = \frac{R^{-4}}{(D + R)^{-4}} = \frac{1}{(q + 1)^{-4}} = 355 = 26 \text{ dB} \quad (9.5-6)$$

If 6 dB is subtracted from the result of Eq. (9.5-6), the remaining 21 dB is adequate. Under heavy traffic conditions, there is still a great deal of concern over using a $K = 4$ cell pattern in a 60° sector. An explanation of this point is given in the next section.

9.5.3 Comparing $K = 7$ and $K = 4$ systems

A $K = 7$ cell-pattern system is a logical way to begin an omniscell system. The cochannel reuse distance is more or less adequate, according to the designed criterion. When the traffic increases, a three-sector system should be implemented, that is, with three 120° directional antennas in place. In certain hot spots, 60° sectors can be used locally to increase the channel utilization.

If a given area is covered by both $K = 7$ and $K = 4$ cell patterns and both patterns have a six-sector configuration, then the $K = 7$ system has a total of 42 sectors, but the $K = 4$ system has a total of only 26 sectors and, of course, the system of $K = 7$ and six sectors has less cochannel interference.

One advantage of 60° sectors with $K = 4$ is that they require fewer cell sites than 120° sectors with $K = 7$. Two disadvantages of 60° sectors are that (1) they require more antennas to be mounted on the antenna mast and (2) they often require more frequent handoffs because of the increased chance that the mobile units will travel across the six sectors of the cell. Furthermore, assigning the proper frequency channel to the mobile unit in each sector is more difficult unless the antenna height at the cell site is increased so that the mobile unit can be located more precisely. In reality the terrain is not flat, and coverage is never uniformly distributed; in addition, the directional antenna front-to-back power ratio in the field is very difficult to predict (see Sec. 8.4.2). In small cells, interference could become uncontrollable; thus the use of a $K = 4$ pattern with 60° sectors in small cells needs to be considered only for special implementations such as portable cellular systems (Sec. 15.6) or narrowbeam applications (Sec. 12.8). For small cells, a better alternative scheme is to use a $K = 7$ pattern with 120° sectors plus the underlay-overlay configuration described in Sec. 13.6.1.

diversity receiver

The diversity scheme applied at the receiving end of the antenna is an effective technique for reducing interference because any measures taken at the receiving end to improve signal performance will not cause additional interference.

The diversity scheme is one of these approaches. We may use a selective combiner to combine two correlated signals as shown in Fig. 9.17. The performance of other kinds of combiners can be at most 2 dB better than that of selective combiners. However, the selective combining technique is the easiest scheme to use.¹²

Figure 9.17 shows a family of curves representing this selective combination. Each curve has an associated correlation coefficient ρ ; when using the diversity scheme, the optimum result is obtained when $\rho = 0$.

We have found that at the cell site the correlation coefficient $\rho \leq 0.7$ should be used¹³ for a two-branch space diversity; with this coefficient the separation of two antennas at the cell site meets the requirement of $h/d = 11$, where h is the antenna height and d is the antenna separation (see Sec. 8.13.5).

At the mobile unit, we can use $\rho = 0$, which implies that the two roof-mounted antennas of the mobile unit are 0.5λ or more apart. This is verified by the measured data shown in Fig. 9.18.¹⁴

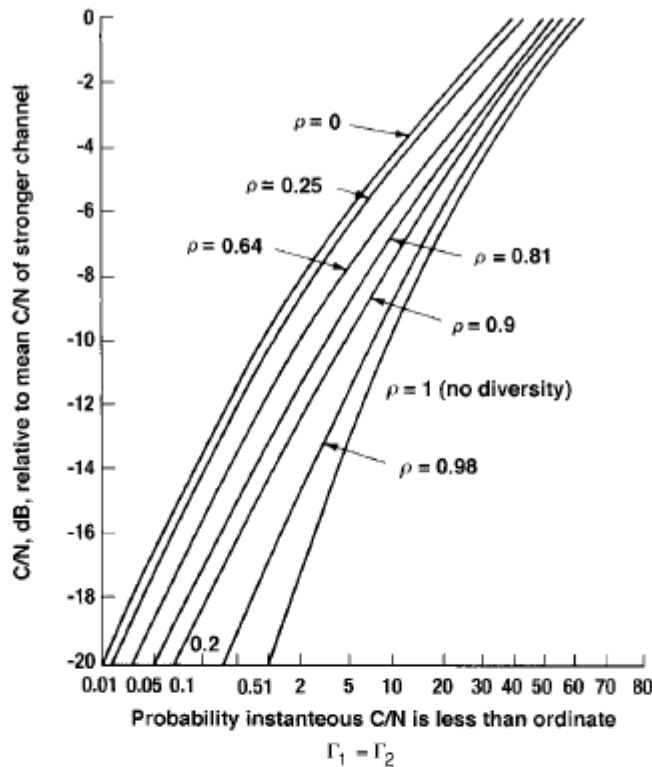

FIGURE 9.17 Selective combining of two correlated signals.

Now we may estimate the advantage of using diversity. First, let us assume a threshold level of 10 dB below the average power level. Then we compare the percent of signal below the threshold level both with and without a diversity scheme.

1. *At the mobile unit.* The comparison is between curves $\rho = 0$ and the $\rho = 1$. The signal below the threshold level is 10 percent for no diversity and 1 percent for diversity. If the signal without diversity were 1 percent below the threshold, the power would be increased by 10 dB (see Fig. 9.17). In other words, if the diversity scheme is used, the power can be reduced by 10 dB for the same performance as in the nondiversity scheme without reducing power. With 10 dB less power transmitted at the cell site, cochannel interference can be drastically reduced.

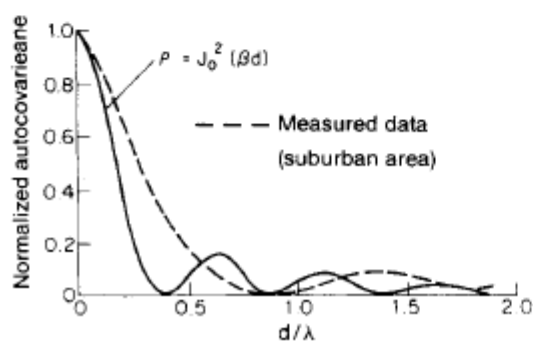

FIGURE 9.18 Autocorrelation coefficient versus spacing for uniform angular distribution (applied to diversity receiver). (Reprint after Lee, Ref. 10.)

2. *At the cell site.* The comparison is between curves of $\rho = 0.7$ and $\rho = 1$. We use curve

$\rho = 0.64$ for a close approximation as shown in Fig. 9.17. The difference is 10 percent of the signal is below threshold level when a nondiversity scheme is used versus 2 percent signal below threshold level when a diversity scheme is used. If the nondiversity signal were 2 percent below the threshold, the power would have to increase by 7 dB (see Fig. 9.17). Therefore, the mobile transmitter (for a cell-site diversity receiver) could undergo a 7-dB reduction in power and attain the same performance as a nondiversity receiver at the cell site. Thus, interference from the mobile transmitters to the cell-site receivers can be drastically reduced.

non-co-channel interference-different types.

ADJACENT-CHANNEL INTERFERENCE

The scheme discussed in Chap. 9 for reduction of cochannel interference can be used to reduce adjacent-channel interference. However, the reverse argument is not valid here. In addition, adjacent-channel interference can be eliminated on the basis of the channel assignment, the filter characteristics, and the reduction of near-end-far-end (ratio) interference.

“Adjacent-channel interference” is a broad term. It includes next-channel (the channel next to the operating channel) interference and neighboring-channel (more than one channel away from the operating channel) interference. Adjacent-channel interference can be reduced by the frequency assignment.

Next-Channel Interference

Next-channel interference in an AMPS system affecting a particular mobile unit cannot be caused by transmitters in the common cell site but must originate at several other cell sites. This is because any channel combiner at the cell site must combine the selected channels, normally 21 channels (630 kHz) away, or at least 8 or 10 channels away from the desired one. Therefore, next-channel interference will arrive at the mobile unit from other cell sites if the system is not designed properly. Also, a mobile unit initiating a call on a control channel in a cell may cause interference with the next control channel at another cell site. The methods for reducing this next-channel interference use the receiving end. The channel filter characteristics⁴ are a 6 dB/oct slope in the voice band and a 24 dB/oct falloff outside the voice-band region (see Fig. 10.3). If the next-channel signal is stronger than 24 dB, it

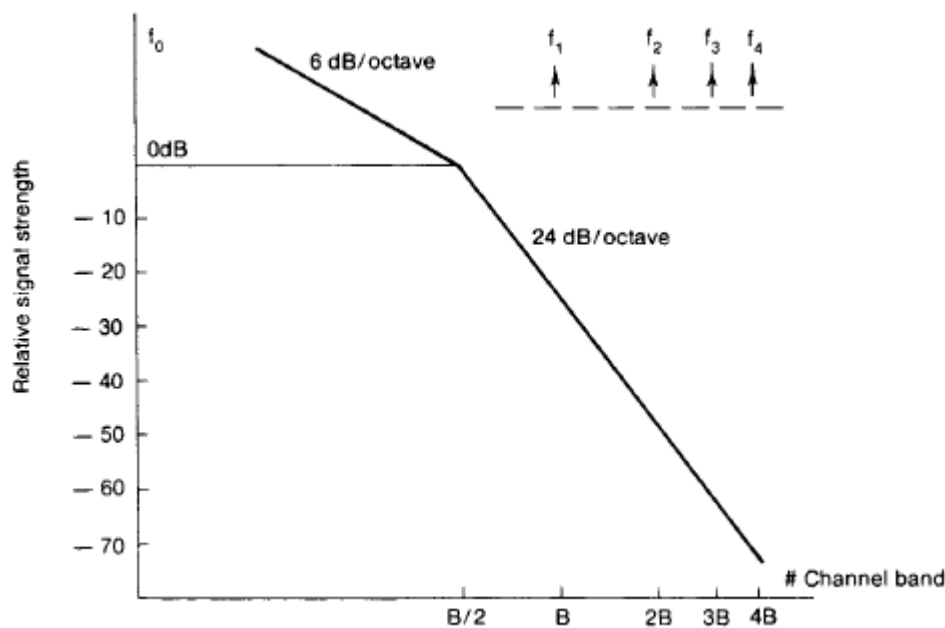

FIGURE 10.3 Characteristics of channel-band filter.

will interfere with the desired signal. The filter with a sharp falloff slope can help to reduce

all the adjacent-channel interference, including the next-channel interference. The same consideration is applied to digital systems.

Neighboring-Channel Interference

The channels that are several channels away from the next channel will cause interference with the desired signal. Usually, a fixed set of serving channels is assigned to each cell site. If all the channels are simultaneously transmitted at one cell-site antenna, a sufficient amount of band isolation between channels is required for a multichannel combiner (see Sec. 10.7.1) to reduce intermodulation products. This requirement is no different from other nonmobile radio systems. Assume that band separation requirements can be resolved, for example, by using multiple antennas instead of one antenna at the cell site. There will be no intermodulation products. A truly linear broadband amplifier can realize this idea. However, it is a new evolving technology.

Another type of adjacent-channel interference is unique to the mobile radio system.

In the mobile radio system, most mobile units are in motion simultaneously. Their relative positions change from time to time. In principle, the optimum channel assignments that avoid adjacent-channel interference must also change from time to time. One unique station that causes adjacent-channel interference in mobile radio systems is described in the next section.

Transmitting and Receiving Channels Interference

In FDMA and TDMA systems, the transmitting channels and receiving channels have to be separated by a guard band mostly 20 MHz. It is because the transmitting channels are so strong that they can mask the weak signals received from the receiving channels. The duplexer can only provide 30 dB to 40 dB isolation. The band isolation is the other means to reduce the interference.

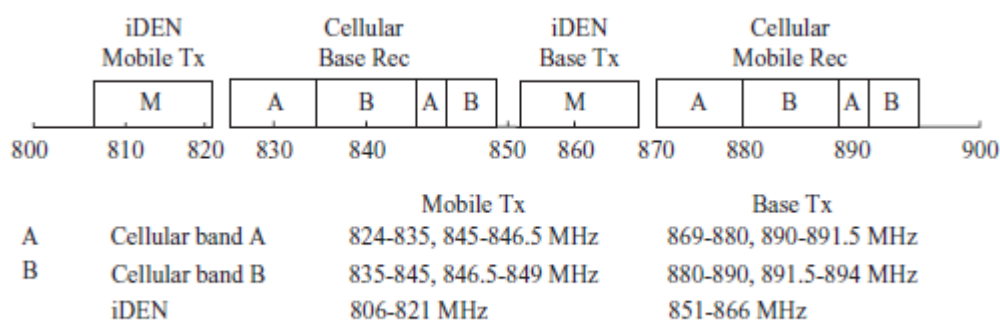

FIGURE 10.4 Cellular and iDEN spectrum in 800 MHz.

Interference from Adjacent Systems

The frequency bands allocated between AMPS and iDEN in 800-MHz systems are shown in Fig. 10.4. In 1993, iDEN transmitted in the band 851–866 MHz, using several broadband amplifiers to cover this band. The IM (2A-B) generated from the nonlinear amplifiers interfered with the cellular base received signals. Then, the broadband amplifiers were removed.

NEAR-END-FAR-END INTERFERENCE

In One Cell

Because motor vehicles in a given cell are usually moving, some mobile units are close to the cell site and some are not. The close-in mobile unit has a strong signal that causes adjacent channel interference (see Fig. 10.5a). In this situation, near-end-far-end interference can occur only at the reception point in the cell site.

If a separation of $5B$ (five channel bandwidths) is needed for two adjacent channels in a cell in order to avoid the near-end-far-end interference, it is then implied that a minimum separation of $5B$ is required between each adjacent channel used with one cell.

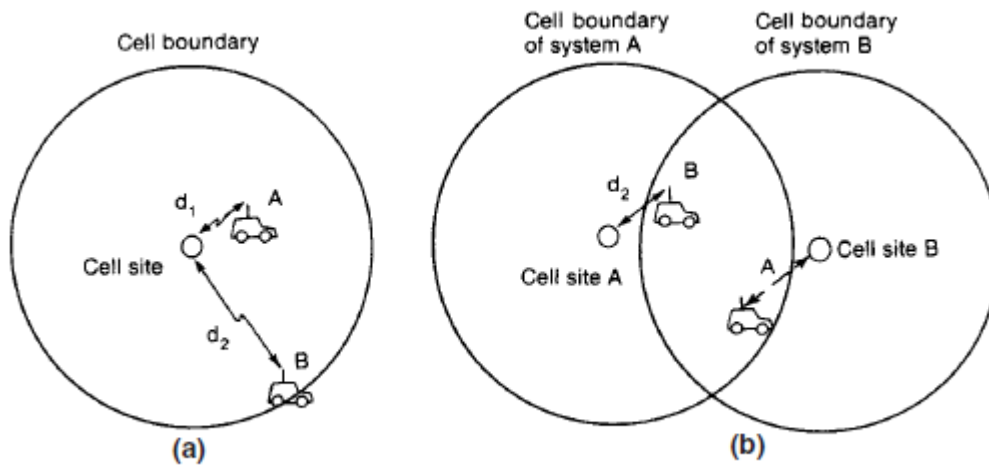

FIGURE 10.5 Near-end-far-end (ratio) interference. (a) In one cell; (b) in two-system cells.

Because the total frequency channels are distributed in a set of N cells, each cell only has $1/N$ of the total frequency channels. We denote $\{F1\}$, $\{F2\}$, $\{F3\}$, $\{F4\}$ for the sets of frequency channels assigned in their corresponding cells $C1$, $C2$, $C3$, $C4$.

The issue here is how can we construct a good frequency management chart to assign the N sets of frequency channels properly and thus avoid the problems indicated above. The following section addresses how cellular system engineers solve this problem in two different systems.

EFFECT ON NEAR-END MOBILE UNITS

Avoidance of Near-End-Far-End Interference

The near-end mobile units are the mobile units that are located very close to the cell site. These mobile units transmit with the same power as the mobile units that are far away from the cell site. The situation described below is illustrated in Fig. 10.7. The distance d_0 between a calling mobile transmitter and a base-station receiver is much larger than the distance d_1 between a mobile transmitter causing interference and the same base-station receiver. Therefore, the transmitter of the mobile unit causing interference is close enough

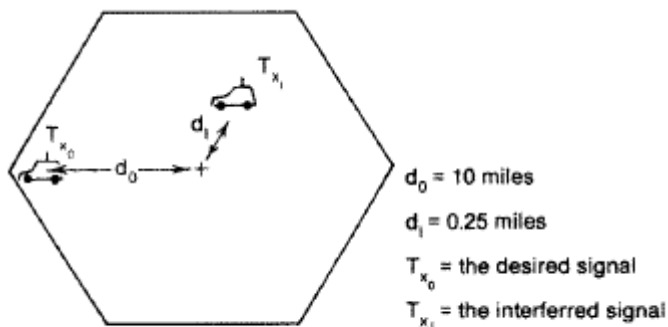

FIGURE 10.7 Near-end-far-end ratio interference.

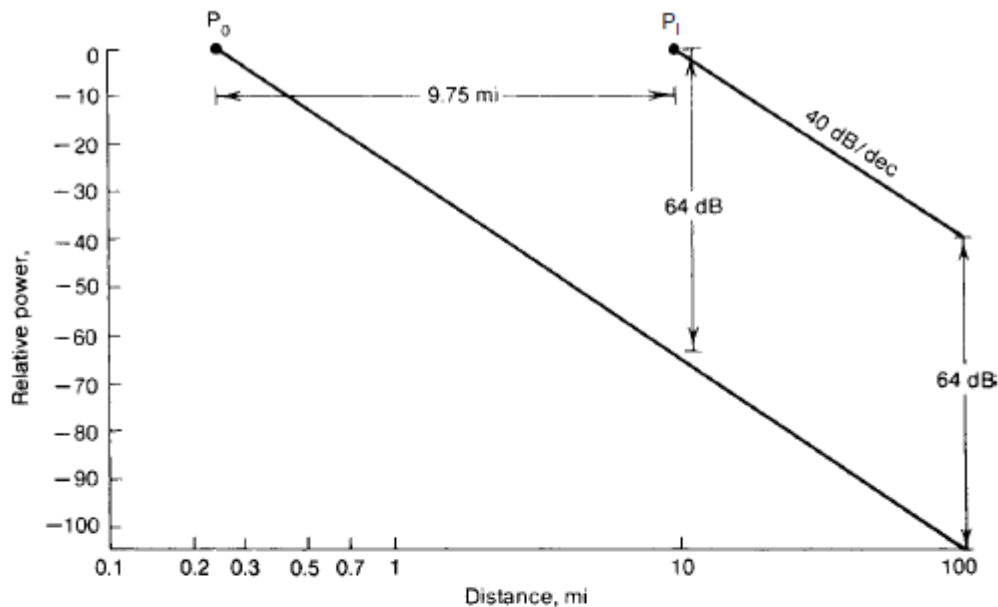

FIGURE 10.8 Using spacing for cochannel isolation.

to override the desired base-station signal.⁵ This interference, which is based on the distance ratio, can be expressed as

$$\frac{C}{I} = \left(\frac{d_0}{d_I} \right)^{-\gamma} \quad (10.4-1)$$

where γ is the path-loss slope. The ratio d_I/d_0 is the near-end-far-end ratio. From Eq. (10.4-1) the effect of the near-end-far-end ratio on the carrier-adjacent-channel interference ratio is dependent on the relative positions of the moving mobile units.

For example, if the calling mobile unit is 10 mi away from the base-station receiver and the mobile unit causing the interference is 0.25 mi away from the base-station receiver, then the carrier-to-interference ratio for interference received at the base-station receiver with $\gamma = 4$ is

$$\frac{C}{I} = \left(\frac{d_0}{d_I} \right)^{-4} = (40)^{-4} = -64 \text{ dB} \quad (10.4-2)$$

This means that the interference is stronger than the desired signal by 64 dB (see Fig. 10.8).

This kind of interference can be reduced only by frequency separation with narrow filter characteristics. Assume that a filter of channel B has a 24 dB/oct slope⁴; then a 24-dB loss begins at the edge of the channel $B/2$. The increase from $B/2$ to B results in 24-dB loss, the increase from B to $2B$ results in another 24-dB loss, and so forth.

In order to achieve a loss of 64 dB, we may have to double the frequency band more than two times as

$$\frac{64}{L} = \frac{64}{24} = 2.67$$

where L is the filter characteristic. The frequency band separation for 64-dB isolation is

$$2^{-(C/I)/L} \left(\frac{B}{2} \right) = 2^{2.67} \left(\frac{B}{2} \right) = 3.18B \quad (10.4-3)$$

Therefore, a minimum separation of four channels is needed to satisfy the isolation criterion of 64 dB. The general formula for the required channel separation is based on the filter characteristic L , which is expressed as follows.⁵

$$\text{Frequency band separation} = 2^{G-1} B \quad (10.4-4)$$

where

$$G = \frac{\gamma \log_{10} \left(\frac{d_0}{d_i} \right)}{L} \quad (10.4-5)$$

10.4.2 Nonlinear Amplification

When the near-end mobile unit is close to the cell site, its transmitted power is too strong and saturates the IF log amplifier if the received signal at the cell site exceeds -55 dBm. A typical log IF amplifier characteristic is shown in Fig. 10.9. Assume that the mobile unit transmitted power is 36 dBm and the antenna gain is 2 dBi. The power plus the gain is 38 dBm. The receiver power is -55 dBm at the cell site.

The propagation loss $L = 38 \text{ dBm} - (-55 \text{ dBm}) = 93 \text{ dB}$. We may calculate the free-space path loss, which is the maximum distance within which the saturation of the IF amplifier will occur. The calculation of free-space loss versus distance at 850 MHz is as follows.

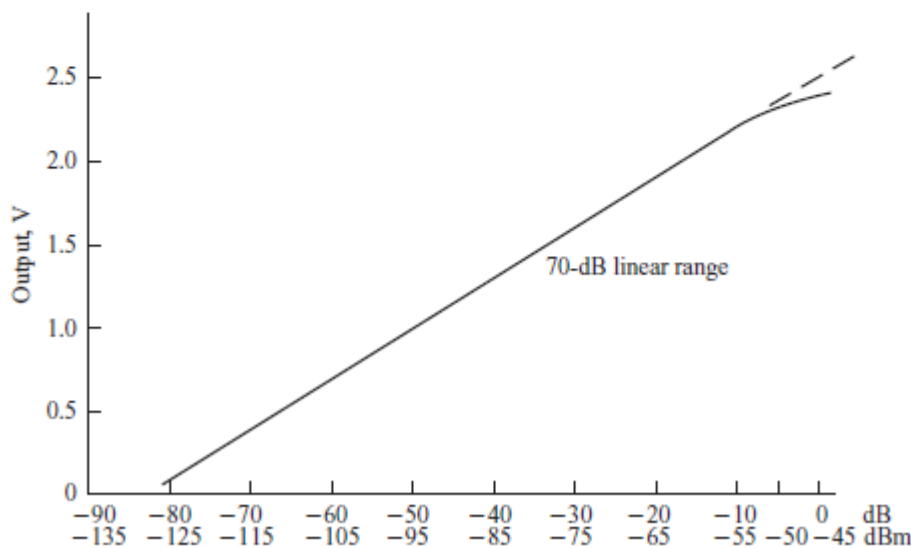

FIGURE 10.9 A typical intermediate-frequency log amplifier.

$$\begin{aligned}
-55 \text{ dBm} &= 10 \log \frac{P}{(4\pi)^2 (d/\lambda)^2} \\
&= 38 \text{ dBm} - 20 \log 4\pi - 20 \log \left(\frac{d}{\lambda} \right) \\
20 \log_{10} \left(\frac{d}{\lambda} \right) &= 55 + 38 - 22 = 71 \qquad (10.4-6) \\
\frac{d}{\lambda} &= 10^{71/20} = 3548 \\
d &= 3548\lambda = 4115 \text{ ft} \\
&= 1241 \text{ m} = 1.24 \text{ km}
\end{aligned}$$

This means that when the mobile unit is within 1.24 km of the cell-site boundary, it is possible to saturate the IF amplifier, and it is likely that intermodulation will be generated because of the nonlinear portion of the characteristics. If the intermodulation (IM) product matches the frequency channel of another mobile unit far away from the cell site where reception is weak, then the IM can interfere with the other frequency received at the cell site.

Therefore, the near-end mobile unit can cause interference at the cell site with the far-end mobile unit by generating IM at the cell-site amplifier and by leaking into the signal of the far-end mobile unit received at the cell site.

Module-IV

CELL COVERAGE FOR SIGNAL AND TRAFFIC :

Cell coverage can be based on signal coverage or on traffic coverage. Signal coverage can be predicted by coverage prediction models and is usually applied to a start-up system. The task is to cover the whole area with a minimum number of cell sites. Because 100 percent cell coverage of an area is not possible, the cell sites must be engineered so that the holes are located in the no-traffic locations. The prediction model is a point-to-point model that is discussed in this chapter. We have to examine the service area as occurring in one of the following environments:

Human-made structures

In a building area

In an open area

In a suburban area

In an urban area

Natural terrains

Over flat terrain

Over hilly terrain

Over water

Through foliage areas

The results generated from the prediction model will differ depending on which service area is used.

There are many field-strength prediction models in the literature.¹⁻²⁸ They all provide more or less an area-to-area prediction. As long as 68 percent of the predicted values from a model are within 6 to 8 dB (one standard deviation) of their corresponding measured value, the model is considered a good one. However, we cannot use area-to-area prediction models for cellular system design because of the large uncertainty of the prediction.

The model being introduced here is the point-to-point prediction model, which would provide a standard deviation from the predicted value of less than 3 dB. An explanation of this model appears in Refs. 23 and 24. Many tools can be developed based upon this model, such as cell-site choosing, interference reduction, and traffic handling.

Signal reflections in flat and hilly terrain:

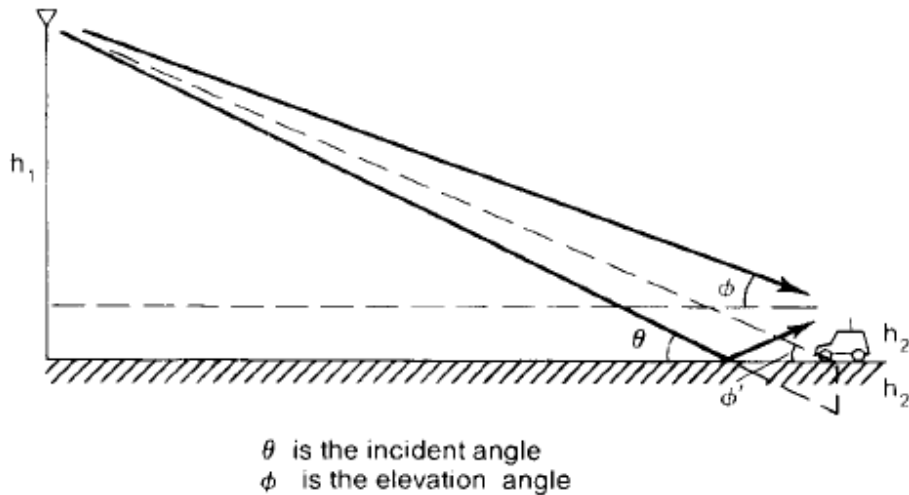

FIGURE 8.1 A coordinate sketch in a flat terrain.

8.1.1 Ground Incident Angle and Ground Elevation Angle

The ground incident angle and the ground elevation angle over a communication link are described as follows. The ground incident angle θ is the angle of wave arrival incidently pointing to the ground as shown in Fig. 8.1. The ground elevation angle ϕ is the angle of wave arrival at the mobile unit as shown in Fig. 8.1.

EXAMPLE 8.1 *In a mobile radio environment, the average cell-site antenna height is about 50 m, the mobile antenna height is about 3 m, and the communication path length is 5 km. The incident angle is (see Fig. 8.1)*

$$\theta = \tan^{-1} \frac{50 \text{ m} + 3 \text{ m}}{5 \text{ km}} = 0.61^\circ$$

The elevation angle at the antenna of the mobile unit is

$$\phi = \tan^{-1} \frac{50 \text{ m} - 3 \text{ m}}{5 \text{ km}} = 0.54^\circ$$

The elevation angle at the location of the mobile unit is

$$\phi' = \tan^{-1} \frac{50 \text{ m}}{5 \text{ km}} = 0.57^\circ$$

8.1.2 Ground Reflection Angle and Reflection Point

Based on Snell's law, the reflection angle and incident angle are the same. Because in graphical display we usually exaggerate the hilly slope and the incident angle by enlarging the vertical scale, as shown in Fig. 8.2, then as long as the actual hilly slope is less than 10° , the reflection point on a hilly slope can be obtained by following the same method as if the reflection point were on flat ground. Be sure that the two antennas (base and mobile) have been placed vertically, not perpendicular to the sloped ground. The reason is that the actual slope of the hill is usually very small and the vertical stands for two antennas are correct. The scale drawing in Fig. 8.2 is somewhat misleading; however, it provides a clear view of the situation.

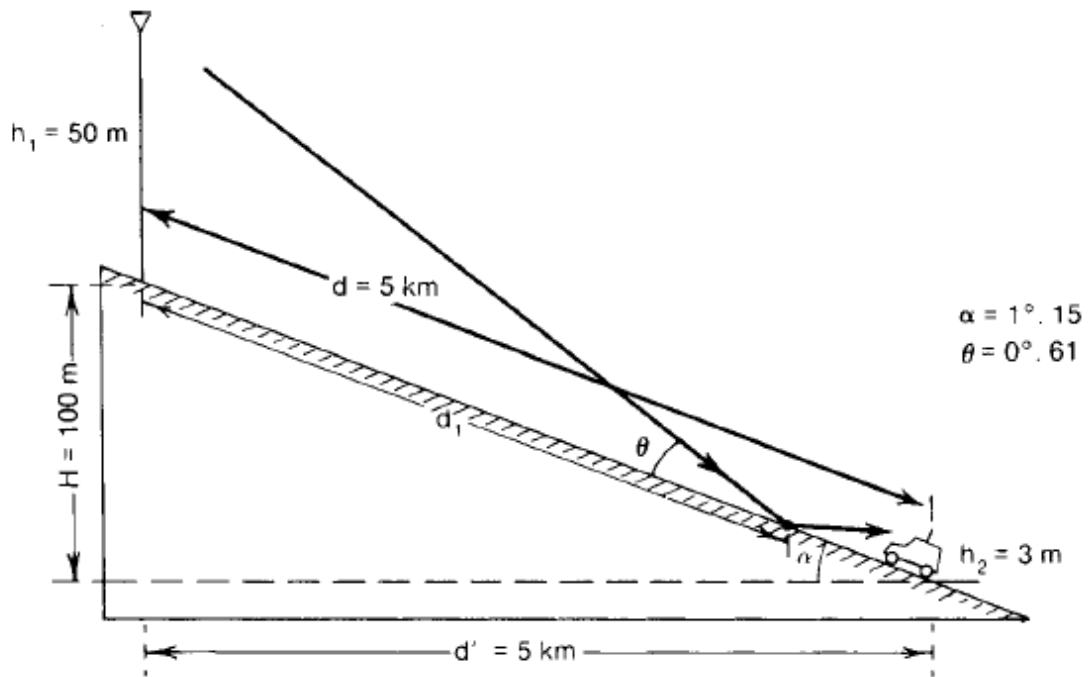

FIGURE 8.2 A coordinate sketch in a hilly terrain.

EXAMPLE 8.2 Let $h_1 = 50$ m, $h_2 = 3$ m, $d = 5$ km, and $H = 100$ m as shown in Fig. 8.2.

(a) Using the approximate method ($d = d' = 5$ km), the slope angle α of the hill is

$$\alpha = \tan^{-1} \frac{100 \text{ m}}{5 \text{ km}} = 1.14576^\circ$$

the incident angle is

$$\theta = \tan^{-1} \frac{50 \text{ m} + 3 \text{ m}}{5 \text{ km}} = 0.61$$

and the reflection point location from the cell-site antenna

$$d_1 = 50 / \tan \theta = 4.717 \text{ km.}$$

(b) Using the accurate method, the slope angle α of the hill is

$$\alpha = \tan^{-1} \frac{100 \text{ m}}{\sqrt{(5 \text{ km})^2 - (100 \text{ m})^2}} = \tan^{-1} \frac{100}{4999} = 1.14599^\circ$$

The incident angle θ and the reflection point location d_1 are the same as above.

This mobile point-to-point model is obtained in three steps: (1) generate a standard condition, (2) obtain an area-to-area prediction model, (3) obtain a mobile point-to-point model using the area-to-area model as a base. The philosophy of developing this model is to try to separate two effects, one caused by the natural terrain contour and the other by the human-made structures, in the received signal strength.

The area-to-area prediction curves are different in different areas. In area-to-area prediction, all the areas are considered flat even though the data may be obtained from nonflat areas. The reason is that area-to-area prediction is an average process. The standard deviation of the average value indicates the degree of terrain roughness.

Effect of the Human-Made Structures. Because the terrain configuration of each city is different, and the human-made structure of each city is also unique, we have to find a way to separate these two. The way to factor out the effect due to the terrain configuration from the man-made structures is to work out a way to obtain the path loss curve for the area as if the area were flat, even if it is not. The path loss curve obtained on virtually flat ground indicates the effects of the signal loss due to solely human-made structures. This means that the different path loss curves obtained in each city show the different human-made structure in that city. To do this, we may have to measure signal strengths at those high spots and also at the low spots surrounding the cell sites, as shown in Fig. 8.3a. Then the average path loss slope (Fig. 8.3b), which is a combination of measurements from high spots and low spots along different radio paths in a general area, represents the signal received as if it is from a flat area affected only by a different local human-made structured environment. We are using 1-mi intercepts (or, alternatively, 1-km intercepts) as a starting point for obtaining the path loss curves.

Therefore, the differences in area-to-area prediction curves are due to the different manmade structures. We should realize that measurements made in urban areas are different from those made in suburban and open areas. The area-to-area prediction curve is obtained from the mean value of the measured data and used for future predictions in that area.

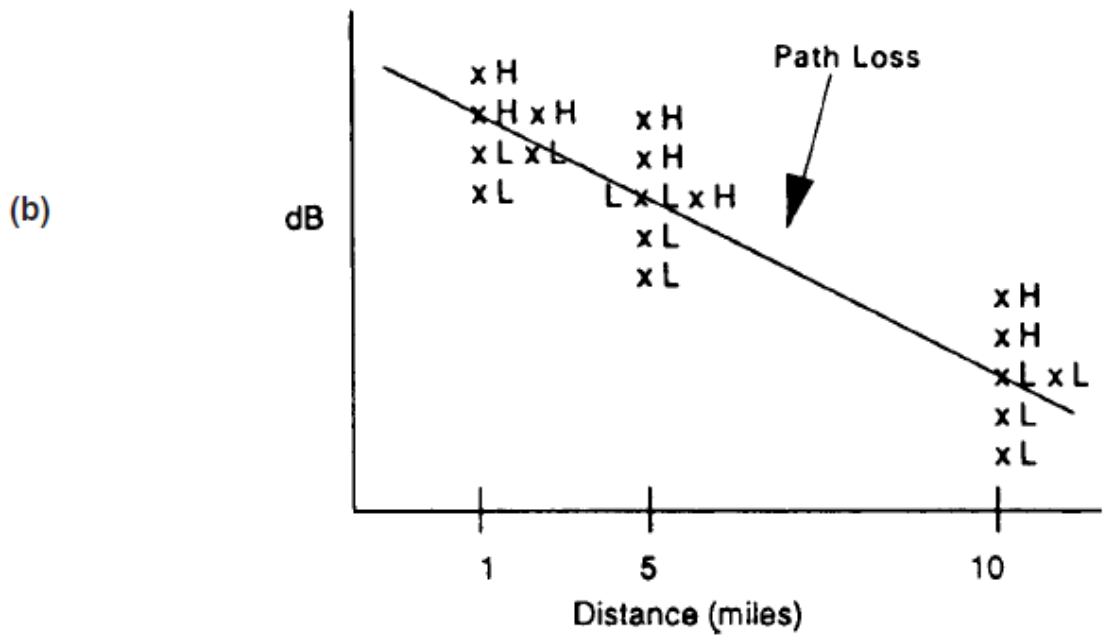
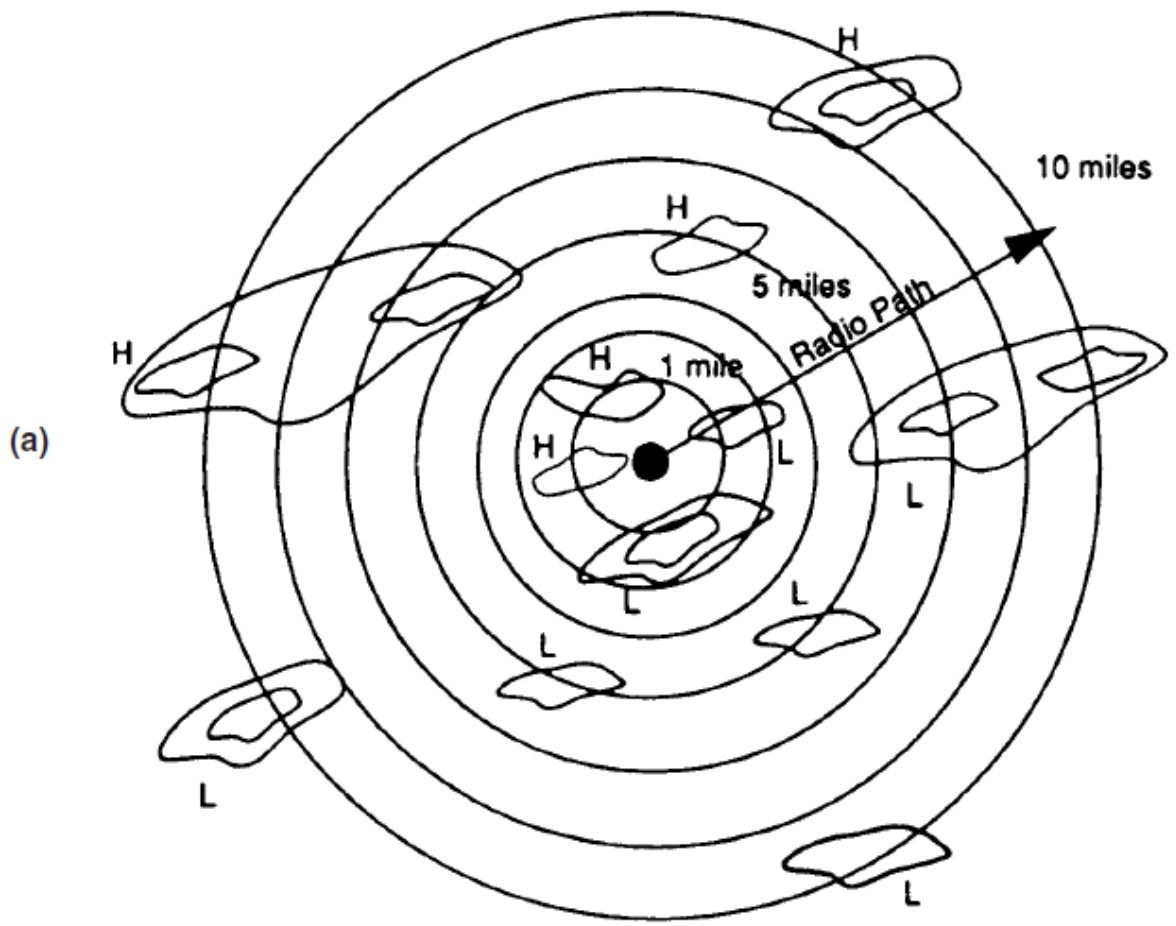

FIGURE 8.3 Propagation path loss curves for human-made structures. (a) For selecting measurement areas (b) path loss phenomenon.

Any area-to-area prediction model¹⁻²⁸ can be used as a first step toward achieving the point-to-point prediction model.

One area-to-area prediction model which is introduced here¹⁰ can be represented by two parameters: (1) the 1-mi (or 1-km) intercept point and (2) the path-loss slope. The 1-mi intercept point is the power received at a distance of 1 mi from the transmitter. There are two general approaches to finding the values of the two parameters experimentally.

1. Compare an area of interest with an area of similar human-made structures which presents a curve such as that shown in Fig. 8.3c. The suburban area curve is a commonly used curve. Because all suburban areas in the United States look alike, we can use this curve

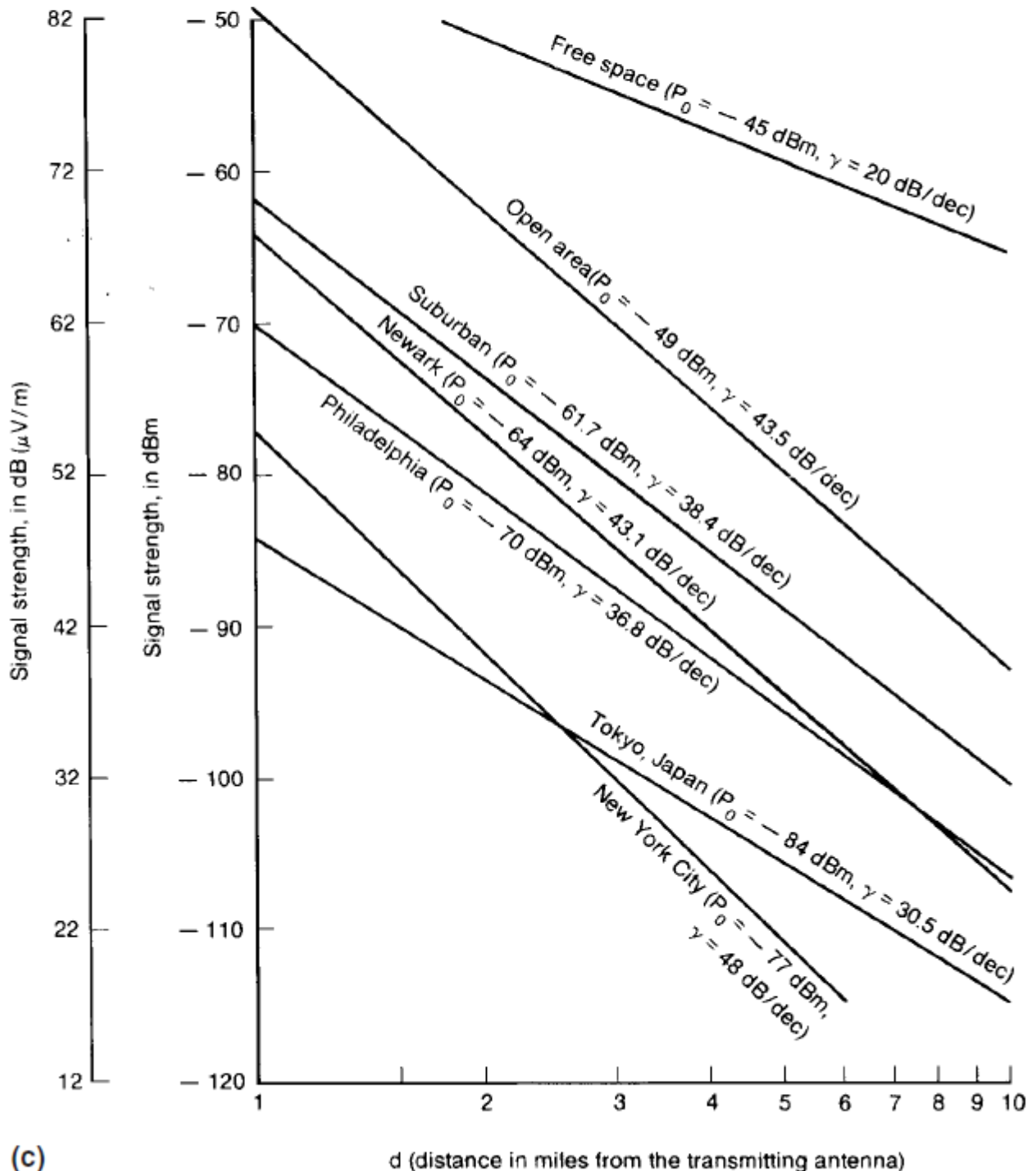

FIGURE 8.3 (Continued) (c) Propagation path loss in different cities.

for all suburban areas. If the area is not suburban but is similar to the city of Newark, then the curve for Newark should be used.

2. If the human-made structures of a city are different from the cities listed in Fig. 8.8c, a simple measurement should be carried out. Set up a transmitting antenna at the center of a general area. As long as the building height is comparable to the others in the area, the antenna location is not critical. Take six or seven measured data points around the 1-mi intercept and around the 10-mi boundary based on the high and low spots. Then compute the average of the 1 mi data points and of the 10 mi data points. By connecting the two values, the path-loss slope can be obtained. If the area is very hilly, then the data points measured at a given distance from the base station in different locations can be far apart. In this case, we may take more measured data points to obtain the average path-loss slope.

If the terrain of the hilly area is generally sloped, then we have to convert the data points that were measured on the sloped terrain to a fictitiously flat terrain in that area. The conversion is based on the effective antenna-height gain as²³

$$\Delta G = \text{effective antenna-height gain} = 20 \log \frac{h_e}{h_1} \quad (8.2-1)$$

where h_1 is the actual height and h_e is the effective antenna height at either the 1- or 10-mi locations. The method for obtaining h_e is shown in the following section.

3. An explanation of the path-loss phenomenon is as follows. The plotted curves shown in Fig. 8.3c have different 1-mi intercepts and different slopes. The explanation can be seen in Fig. 8.3d. When the base station antenna is located in the city, then the 1-mi intercept could be very low and the slope is flattened out, as shown by Tokey's curve. When the base station is located outside the city, the intercept could be much higher and the slope is deeper, as shown by the Newark curve. When the structures are uniformly distributed, depending on the density (average separation between buildings) s shown in Fig. 8.3d, the 1-mi intercept could be high or low, but the slope may also keep at 40 dB/dec.

phase difference between direct and reflected paths:

Based on a direct path and a ground-reflected path (see Fig. 8.4), where a direct path is a line-of-sight (LOS) path with its received power

$$P_{\text{Los}} = P_0 \left(\frac{1}{4\pi d/\lambda} \right)^2 \quad (8.2-2)$$

and a ground-reflected path with its reflection coefficient and phase changed after reflection, the sum of the two wave paths can be expressed as:

$$P_r = P_0 \left(\frac{1}{4\pi d/\lambda} \right)^2 \left| 1 + a_v e^{j\Delta\phi} \right|^2 \quad (8.2-3a)$$

where

a_v = the reflection coefficient

$\Delta\phi$ = the phase difference between a direct path and a reflected path

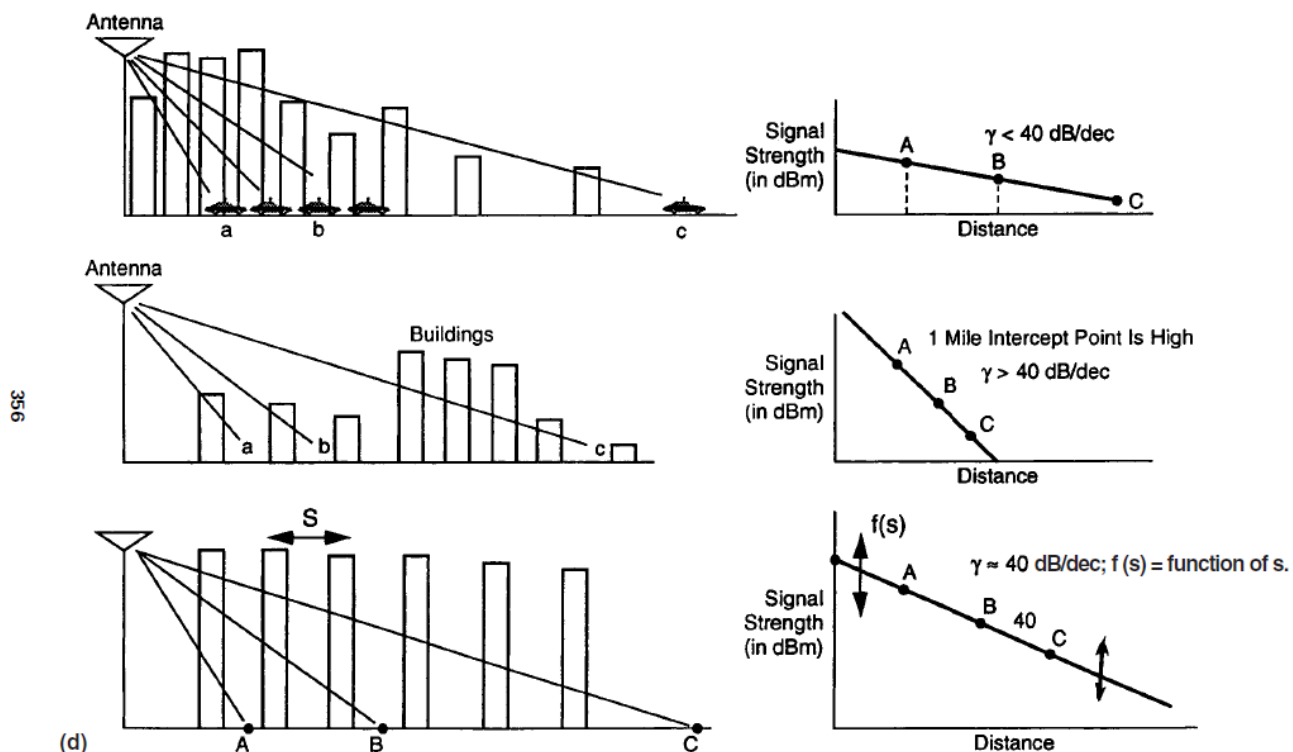

FIGURE 8.3 (Continued) (d) Explanation of the path-loss phenomenon.

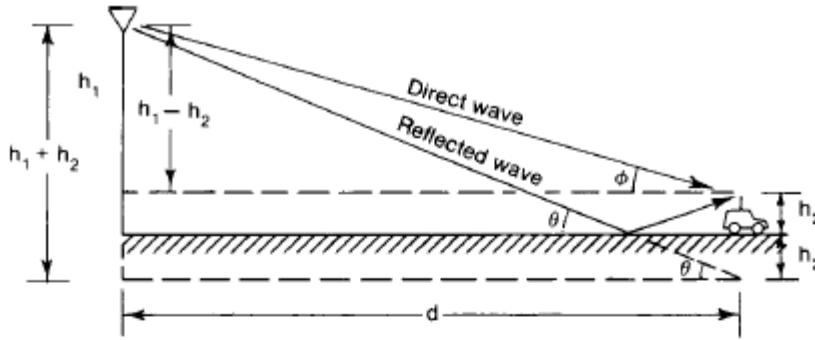

FIGURE 8.4 A simple model.

P_0 = the transmitted power

d = the distance

λ = the wavelength

Equation (8.2-2) indicates a two-wave model, which is used to understand the path-loss phenomenon in a mobile radio environment. It is not the model for analyzing the multipath fading phenomenon. In a mobile environment $a_e = -1$ because of the small incident angle of the ground wave caused by a relatively low cell-site antenna height.

Thus²⁹

$$\begin{aligned}
 P_r &= P_0 \left(\frac{1}{4\pi d/\lambda} \right)^2 \left| 1 - \cos \Delta\phi - j \sin \Delta\phi \right|^2 \\
 &= P_0 \frac{2}{(4\pi d/\lambda)^2} (1 - \cos \Delta\phi) = P_0 \frac{4}{(4\pi d/\lambda)^2} \sin^2 \frac{\Delta\phi}{2} \quad (8.2-3b)
 \end{aligned}$$

where

$$\Delta\phi = \beta \Delta d \quad (8.2-4)$$

and Δd is the difference, $\Delta d = d_1 - d_2$ from Fig. 8.4.

$$d_1 = \sqrt{(h_1 + h_2)^2 + d^2} \quad (8.2-5)$$

and

$$d_2 = \sqrt{(h_1 - h_2)^2 + d^2} \quad (8.2-6)$$

Because Δd is much smaller than either d_1 or d_2 ,

$$\Delta\phi = \beta \Delta d \approx \frac{2\pi}{\lambda} \frac{2h_1 h_2}{d} \quad (8.2-7)$$

Then the received power of Eq. (8.2-3) becomes

$$P_r = P_0 \frac{\lambda^2}{(4\pi)^2 d^2} \sin^2 \frac{4\pi h_1 h_2}{\lambda d} \quad (8.2-8)$$

If $\Delta\phi$ is less than 0.6 rad, then $\sin(\Delta\phi/2) \approx \Delta\phi/2$, $\cos(\Delta\phi/2) \approx 1$ and Eq. (8.2-8) simplifies to

$$P_r = P_0 \frac{4}{16\pi^2 (d/\lambda)^2} \left(\frac{2\pi h_1 h_2}{\lambda d} \right)^2 = P_0 \left(\frac{h_1 h_2}{d^2} \right)^2 \quad (8.2-9)$$

From Eq. (8.2-9), we can deduce two relationships as follows:

$$\Delta P = 40 \log \frac{d_1}{d_2} \quad (\text{a } 40 \text{ dB/dec path loss}) \quad (8.2-10a)$$

$$\Delta G = 20 \log \frac{h'_1}{h_1} \quad (\text{an antenna height gain of } 6 \text{ dB/oct}) \quad (8.2-10b)$$

where ΔP is the power difference in decibels between two different path lengths and ΔG is the gain (or loss) in decibels obtained from two different antenna heights at the cell site. From these measurements, the gain from a mobile antenna height is only 3 dB/oct, which is different from the 6 dB/oct for h'_1 shown in Eq. (8.2-10b). Then

$$\Delta G' = 10 \log \frac{h'_2}{h_2} \quad (\text{an antenna-height gain of } 3 \text{ dB/oct}) \quad (8.2-10c)$$

constant standard deviation.

When plotting signal strengths at any given radio-path distance, the deviation from predicted values is approximately 8 dB. This standard deviation of 8 dB is roughly true in many different areas. The explanation is as follows. When a line-of-sight path exists, both the direct wave path and reflected wave path are created and are strong (see Fig. 8.2). When an out-of-sight path exists, both the direct wave path and the reflected wave path are weak. In either case, according to the theoretical model, the 40-dB/dec path-loss slope applies. The difference between these two conditions is the 1-mi intercept (or 1-km intercept) point. It can be seen that in the open area, the 1-mi intercept is high. In the urban area, the 1-mi intercept is low. The standard deviation obtained from the measured data remains the same along the different path-loss curves regardless of environment.

Support for the above argument can also be found from the observation that the standard deviation obtained from the measured data along the predicted path-loss curve is approximately 8 dB. The explanation is that at a distance from the cell site, some mobile unit radio paths are line-of-sight, some are partial line-of-sight, and some are out-of-sight.

straight line path loss slope:

As we described earlier, the path-loss curves are obtained from many different runs at many different areas. As long as the distances of the radio path from the cell site to the mobile unit

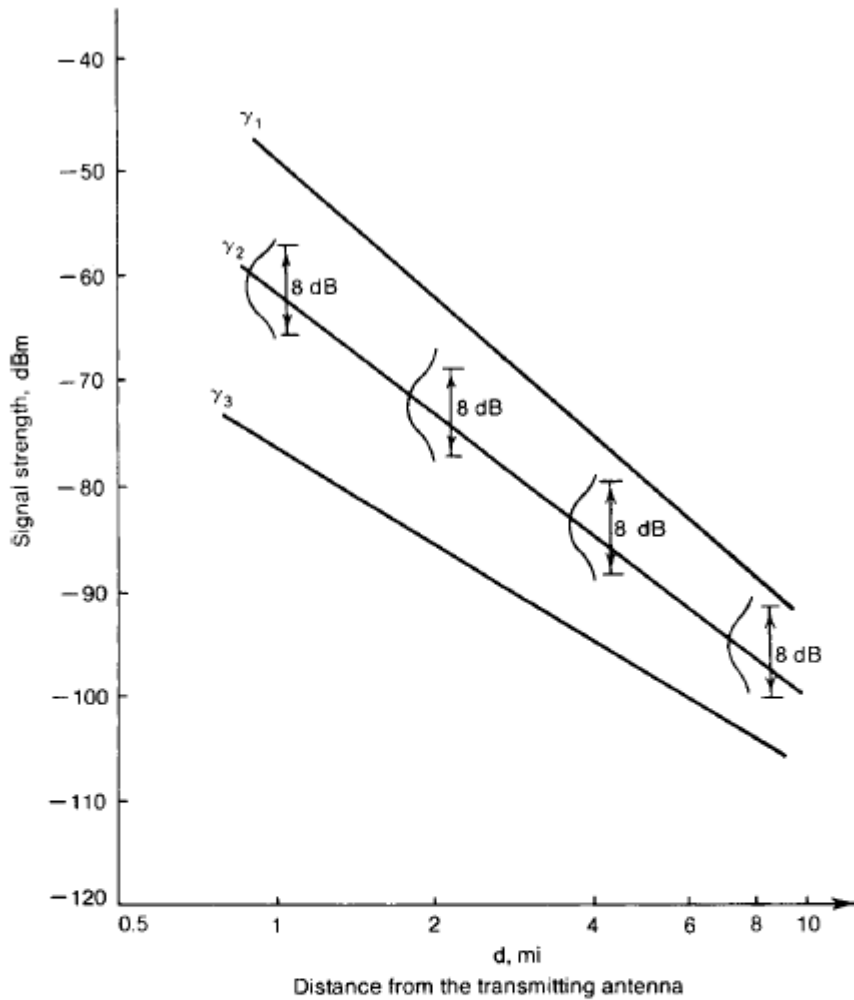

FIGURE 8.5 An 8-dB local mean spread.

Thus, the received signals are strong, normal, and weak, respectively. At any distance, the above situations prevail. If the standard deviation is 8 dB at one radio-path distance, the same 8 dB will be found at any distance. Therefore a standard deviation of 8 dB is always found along the radio path as shown in Fig. 8.5. The standard deviation of 8 dB from the measured data near the cell site is due mainly to the close-in buildings around the cell site. The same standard deviation from the measured data at a distant location is due to the great variation along different radio paths.

are the same in different runs, the signal strength data measured at that distance would be used to calculate the mean value for the path loss at that distance. In the experimental data, the path-loss deviation is 8 dB across the distance from 1.6 to 15 km (1 to 10 mi) where the general terrain contours are not generally flat. Figure 8.5 depicts this. The path-loss curve is γ . The received power can be expressed as

$$P_r = P_0 - \gamma \log \frac{r}{r_0} \quad (8.2-11)$$

The slope γ is different in different areas, but it is always a straight line in a log scale. If $\gamma = 20$ is a free-space path loss, $\gamma = 40$ is a mobile path loss.

8.2.5.1 Confidence Level.³⁰ A confidence level can only be applied to the path-loss curve when the standard deviation σ is known. In American suburban areas, the standard deviation $\sigma = 8$ dB. The values at any given distance over the radio path are concentrated close to the mean and have a bell-shaped (normal) distribution. The probability that 50 percent of the measured data are equal to or below a given level is²⁹

$$P(x \geq C) = \int_C^{\infty} \frac{1}{\sqrt{2\pi}\sigma} e^{-(x-A)^2/2\sigma^2} dx = 50\% \quad (8.2-12)$$

where A is the mean level obtained along the path-loss slope, which is shown in Eq. (8.2-11) as

$$A = P_0 - \gamma \log \frac{r_1}{r_0}$$

Thus, level A corresponds to the distance r_1 . If level A increases, the confidence level decreases, as shown in Eq. (8.2-12).

$$P(x \geq C) = P\left(\frac{x - A}{\sigma} \geq B\right) \quad (8.2-13)$$

Let $C = B\sigma + A$. The different confidence levels are shown in Table 8.2. We can see how to use confidence levels from the following example.

EXAMPLE 8.4 From the path-loss curve, we read the expected signal level as -100 dBm at 16 km (10 mi). If the standard deviation $\sigma = 8$ dB, what level would the signal equal or exceed for a 20 percent confidence level?

TABLE 8.2 The Different Confidence Levels

| $P(x \leq C), \%$ | $C = B\sigma + A$ |
|-------------------|-------------------|
| 80 | $-0.85\sigma + A$ |
| 70 | $-0.55\sigma + A$ |
| 60 | $-0.25\sigma + A$ |
| 50 | A |
| 40 | $0.25\sigma + A$ |
| 30 | $0.55\sigma + A$ |
| 20 | $0.85\sigma + A$ |
| 16 | $1\sigma + A$ |
| 10 | $1.3\sigma + A$ |
| 2.28 | $2\sigma + A$ |

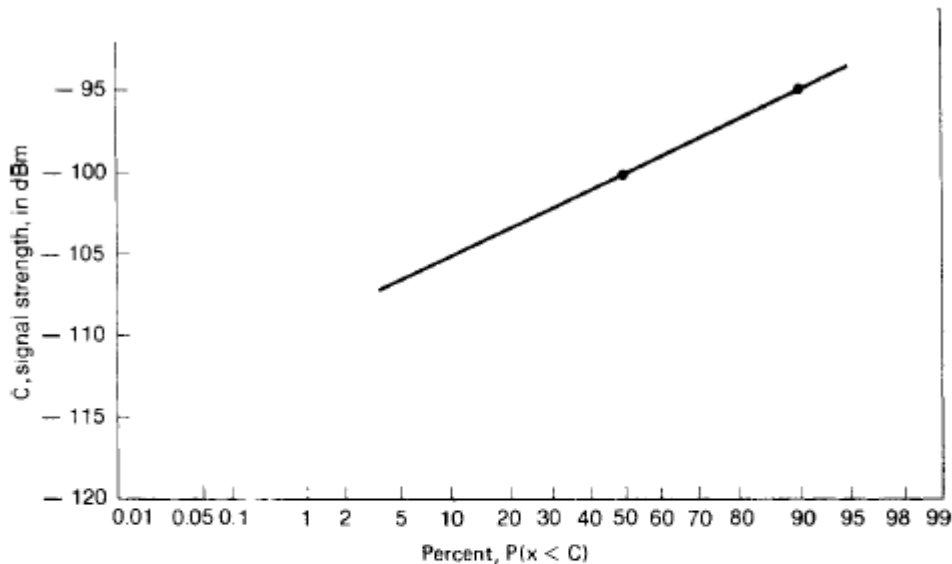

FIGURE 8.6 A log-normal curve.

$$P\left(\frac{x - A}{\sigma} \geq B\right) = 20\% \quad x \geq B\sigma + A \quad (\text{E8.4-1})$$

or from Table 8.2 we obtain

$$x \geq 0.85 \times 8 + (-100) = -93.2 \text{ dBm}$$

The log normal curve with a standard deviation of 8 dB is shown in Fig. 8.6.

Propagation over water or flat open area is becoming a big concern because it is very easy to interfere with other cells if we do not make the correct arrangements. Interference resulting from propagation over the water can be controlled if we know the cause.

In general, the permittivities ϵ_r of seawater and fresh water are the same, but the conductivities of seawater and fresh water are different. We may calculate the dielectric constants ϵ_c , where $\epsilon_c = \epsilon_r - j60\sigma\lambda$. The wavelength at 850 MHz is 0.35 m. Then ϵ_c (seawater) = $80 - j84$ and ϵ_c (fresh water) = $80 - j0.021$.

However, based upon the reflection coefficients formula^{33,34} with a small incident angle, both the reflection coefficients for horizontal polarized waves and vertically polarized waves approach 1. Because the 180° phase change occurs at the ground reflection point, the reflection coefficient is -1 . Now we can establish a scenario, as shown in Fig. 8.7. Because the two antennas, one at the cell site and the other at the mobile unit, are well above sea level, two reflection points are generated. The one reflected from the ground is close to the mobile unit; the other reflected from the water is away from the mobile unit. We recall that the only reflected wave we considered in the land mobile propagation is the one reflection point which is always very close to the mobile unit. We are now using the formula to find the field

general formula for mobile propagation over water and flat open area:

The $a_v e^{-j\phi_v}$ are the complex reflection coefficients and can be found from the formula³³

$$a_v e^{-j\phi_v} = \frac{\epsilon_c \sin \theta_1 - (\epsilon_c - \cos^2 \theta_1)^{1/2}}{\epsilon_c \sin \theta_1 + (\epsilon_c - \cos^2 \theta_1)^{1/2}} \quad (8.3-4)$$

When the vertical incidence is small, θ is very small and

$$a_v \approx -1 \quad \text{and} \quad \phi_v = 0 \quad (8.3-5)$$

can be found from Eq. (8.3-4), ϵ_c is a dielectric constant that is different for different media. However, when $a_v e^{-j\phi_v}$ is independent of ϵ_c , the reflection coefficient remains -1 regardless of whether the wave is propagated over water, dry land, wet land, ice, and so forth. The wave propagating between fixed stations is illustrated in Fig. 8.8. Equation (8.3-1) then becomes

$$\begin{aligned} P_r &= \frac{P_t}{(4\pi d/\lambda)^2} \left| 1 - \cos \Delta\phi - j \sin \Delta\phi \right|^2 \\ &= P_0(2 - 2 \cos \Delta\phi) \end{aligned} \quad (8.3-6)$$

as $\Delta\phi$ is a function of Δd and Δd can be obtained from the following calculation. The effective antenna height at antenna 1 is the height above the sea level.

$$h'_1 = h_1 + H_1$$

The effective antenna height at antenna 2 is the height above the sea level.

$$h'_2 = h_2 + H_2$$

as shown in Fig. 8.8, where h_1 and h_2 are actual heights and H_1 and H_2 are the heights of hills. In general, both antennas at fixed stations are high, so the reflection point of the wave will be found toward the middle of the radio path. The path difference Δd can be obtained from Fig. 8.8 as

$$\Delta d = \sqrt{(h'_1 + h'_2)^2 + d^2} - \sqrt{(h'_1 - h'_2)^2 + d^2} \quad (8.3-7)$$

Because $d \gg h'_1$ and h'_2 , then

$$\Delta d \approx d \left[1 + \frac{(h'_1 + h'_2)^2}{2d^2} - 1 - \frac{(h'_1 - h'_2)^2}{2d^2} \right] = \frac{2h'_1 h'_2}{d} \quad (8.3-8)$$

Then, Eq. (8.3-2) becomes

$$\Delta\phi = \frac{2\pi}{\lambda} \frac{2h'_1 h'_2}{d} = \frac{4\pi h'_1 h'_2}{\lambda d} \quad (8.3-9)$$

Examining Eq. (8.3-6), we can set up five conditions:

1. $P_r < P_0$. The received power is less than the power received in free space; that is,

$$2 - 2 \cos \Delta\phi < 1 \quad \text{or} \quad \Delta\phi < \frac{\pi}{3} \quad (8.3-10)$$

2. $P_r = 0$; that is,

$$2 - 2 \cos \Delta\phi = 0 \quad \text{or} \quad \Delta\phi = \frac{\pi}{2}$$

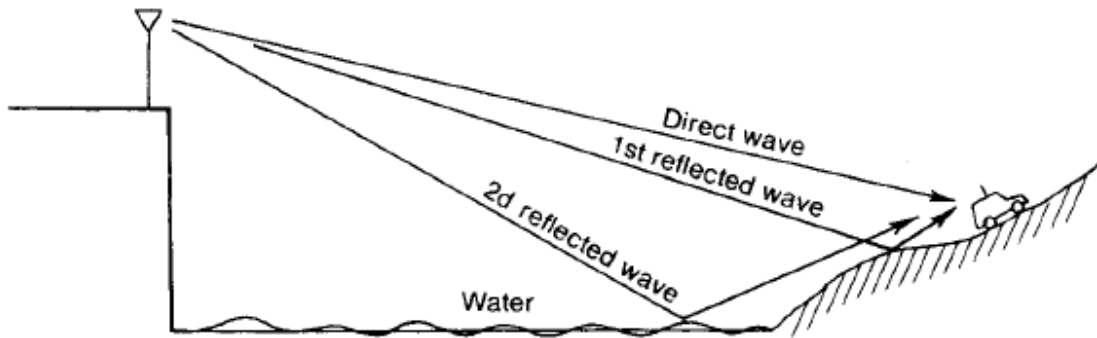

FIGURE 8.7 A model for propagation over water.

strength under the circumstances of a fixed point-to-point transmission and a land-mobile transmission over a water or flat open land condition.

8.3.1 Between Fixed Stations

The point-to-point transmission between the fixed stations over the water or flat open land can be estimated as follows. The received power P_r can be expressed as (see Fig. 8.8)

$$P_r = P_t \left(\frac{1}{4\pi d/\lambda} \right)^2 \left| 1 + a_v e^{-j\phi_v} \exp(j\Delta\phi) \right|^2 \quad (8.3-1)$$

where P_t = the transmitted power

d = distance between two stations

λ = wavelength

a_v, ϕ_v = amplitude and phase of a complex reflection coefficient, respectively

$\Delta\phi$ is the phase difference caused by the path difference Δd between the direct wave and the reflected wave, or

$$\Delta\phi = \beta \Delta d = \frac{2\pi}{\lambda} \Delta d \quad (8.3-2)$$

The first part of Eq. (8.3-1) is the free-space loss formula which shows the 20 dB/dec slope; that is, a 20-dB loss will be seen when propagating from 1 to 10 km.

$$P_0 = \frac{P_t}{(4\pi d/\lambda)^2} \quad (8.3-3)$$

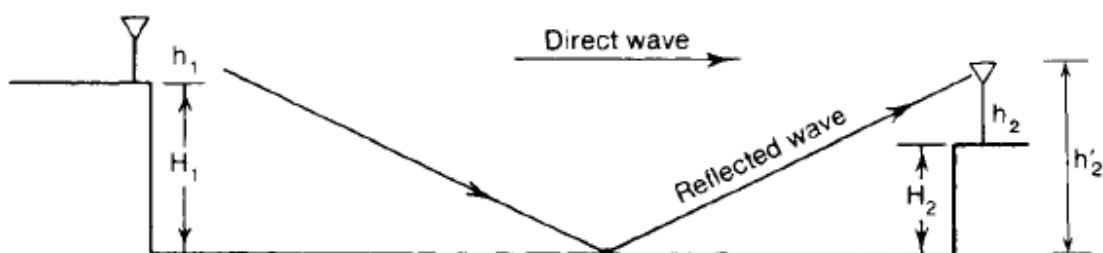

FIGURE 8.8 Propagation between two fixed stations over water or flat open land.

The $a_v e^{-j\phi_v}$ are the complex reflection coefficients and can be found from the formula³³

$$a_v e^{-j\phi_v} = \frac{\epsilon_c \sin \theta_1 - (\epsilon_c - \cos^2 \theta_1)^{1/2}}{\epsilon_c \sin \theta_1 + (\epsilon_c - \cos^2 \theta_1)^{1/2}} \quad (8.3-4)$$

When the vertical incidence is small, θ is very small and

$$a_v \approx -1 \quad \text{and} \quad \phi_v = 0 \quad (8.3-5)$$

can be found from Eq. (8.3-4), ϵ_c is a dielectric constant that is different for different media. However, when $a_v e^{-j\phi_v}$ is independent of ϵ_c , the reflection coefficient remains -1 regardless of whether the wave is propagated over water, dry land, wet land, ice, and so forth. The wave propagating between fixed stations is illustrated in Fig. 8.8. Equation (8.3-1) then becomes

$$\begin{aligned} P_r &= \frac{P_t}{(4\pi d/\lambda)^2} \left| 1 - \cos \Delta\phi - j \sin \Delta\phi \right|^2 \\ &= P_0 (2 - 2 \cos \Delta\phi) \end{aligned} \quad (8.3-6)$$

as $\Delta\phi$ is a function of Δd and Δd can be obtained from the following calculation. The effective antenna height at antenna 1 is the height above the sea level.

$$h'_1 = h_1 + H_1$$

The effective antenna height at antenna 2 is the height above the sea level.

$$h'_2 = h_2 + H_2$$

as shown in Fig. 8.8, where h_1 and h_2 are actual heights and H_1 and H_2 are the heights of hills. In general, both antennas at fixed stations are high, so the reflection point of the wave will be found toward the middle of the radio path. The path difference Δd can be obtained from Fig. 8.8 as

$$\Delta d = \sqrt{(h'_1 + h'_2)^2 + d^2} - \sqrt{(h'_1 - h'_2)^2 + d^2} \quad (8.3-7)$$

Because $d \gg h'_1$ and h'_2 , then

$$\Delta d \approx d \left[1 + \frac{(h'_1 + h'_2)^2}{2d^2} - 1 - \frac{(h'_1 - h'_2)^2}{2d^2} \right] = \frac{2h'_1 h'_2}{d} \quad (8.3-8)$$

Then, Eq. (8.3-2) becomes

$$\Delta\phi = \frac{2\pi}{\lambda} \frac{2h'_1 h'_2}{d} = \frac{4\pi h'_1 h'_2}{\lambda d} \quad (8.3-9)$$

Examining Eq. (8.3-6), we can set up five conditions:

1. $P_r < P_0$. The received power is less than the power received in free space; that is,

$$2 - 2 \cos \Delta\phi < 1 \quad \text{or} \quad \Delta\phi < \frac{\pi}{3} \quad (8.3-10)$$

2. $P_r = 0$; that is,

$$2 - 2 \cos \Delta\phi = 0 \quad \text{or} \quad \Delta\phi = \frac{\pi}{2}$$

3. $P_r = P_0$; that is,

$$2 - 2 \cos \Delta\phi = 1 \quad \text{or} \quad \Delta\phi = \pm 60^\circ = \pm \frac{\pi}{3} \quad (8.3-11)$$

4. $P_r > P_0$; that is,

$$2 - 2 \cos \Delta\phi > 1 \quad \text{or} \quad \frac{\pi}{3} < \Delta\phi < \frac{5\pi}{3} \quad (8.3-12)$$

5. $P_r = 4P_0$; that is,

$$2 - 2 \cos \Delta\phi = \max \quad \text{or} \quad \Delta\phi = \pi \quad (8.3-13)$$

near and long distance propagation antenna height gain:

The advantage of a high cell site is that it covers the signal in a large area, especially in a noise-limited system where usually different frequencies are repeatedly used in different areas. However, we have to be aware of the long-distance propagation phenomenon. A noise-limited system gradually becomes an interference-limited system as the traffic increases.^{40–41} The interference is due to not only the existence of many cochannels and adjacent channels in the system, but the long-distance propagation also affects the interference.

Within an Area of 50-mi Radius

For a high site, the low-atmospheric phenomenon would cause the ground wave path to propagate in a non-straight-line fashion. The phenomenon is usually more pronounced over seawater because the atmospheric situation over the ocean can be varied based on the different altitudes. The wave path can bend either upward or downward. Then we may have the experience that at one spot the signal may be strong at one time but weak at another.

At a Distance of 320 km (200 mi)

Tropospheric wave propagation prevails at 800 MHz for long-distance propagation; sometimes the signal can reach 320 km (200 mi) away.

The wave is received 320 km away because of an abrupt change in the effective dielectric constant of the troposphere (10 km above the surface of the earth). The dielectric constant changes with temperature, which decreases with height at a rate of about 6.5°C/km and reaches -50°C at the upper boundary of the troposphere. In tropospheric propagation, the wave may be divided by refraction and reflection.

*Tropospheric refraction.*⁴⁰ This refraction is a gradual bending of the rays due to the changing effective dielectric constant of the atmosphere through which the wave is passing.

Tropospheric reflection. This reflection will occur where there are abrupt changes in the dielectric constant of the atmosphere. The distance of propagation is much greater than the line-of-sight propagation.

Moistness. Actually water content has much more effect than temperature on the dielectric constant of the atmosphere and on the manner in which the radio waves are affected.

The water vapor pressure decreases as the height increases.

If the refraction index decreases with height over a portion of the range of height, the rays will be curved downward, and a condition known as *trapping*, or *duct propagation*, can occur. There are surface ducts and elevated ducts. Elevated ducts are due to large air masses and are common in southern California. They can be found at elevations of 300 to 1500 m (1000 to 5000 ft) and may vary in thickness from a few feet to a thousand feet. Surface ducts appear over the sea and are about 1.5 m (5 ft) thick. Over land areas, surface ducts are produced by the cooling air of the earth.

Tropospheric wave propagation does cause interference and can only be reduced by umbrella antenna beam patterns, a directional antenna pattern, or a low-power low-antennamast approach.

form of a point to point model:

Lee⁴⁴ developed this point-to-point model in 1977, and its software implementation at AT&T Bell Lab, called ACE (Area Coverage Estimation), an in-house prediction tool called ADMS (Area Deployment of Mobile Systems), was used for deploying seven Baby Bell first-generation cellular systems in their markets in the early 1980s. Later, the portable version of ACE (PACE) could be sold as a product. Then, the model was modified by PacTel and AirTouch and called Pheonex⁴⁵ and used in AirTouch only markets, domestic (USA) and international (Europe, Korea and Japan), with successful results. The model had been taught in George Washington University as a short course from 1982 to 1998.⁴⁶ This model is a methodology, not a formula. The man-made environments are different in different areas, and to predict the signal strength on every local street is needed in the first build-up cellular system for coverage purposes. This model can provide quality coverage with minimum equipment. However, this model needs a terrain database and a computer program. Therefore, it is not easy to use as a formula for a quick prediction to be referred in academic papers. Nevertheless, the prediction results can provide an amazing match with the actual measured data as AirTouch constantly made evaluation internally with other market models.

Lee's point-to-point model has been described. The formula of the Lee model can be stated simply in three cases:

1. *Direct-wave case*. The effective antenna height is a major factor which varies with the location of the mobile unit while it travels.
 2. *Shadow case*. No effective antenna height exists. The loss is totally due to the knife-edge diffraction loss.
 3. *Over-the-water condition*. The free space path-loss is applied.
-

We form the model as follows:

$$P_r = \begin{cases} \text{Nonobstructive path} \\ = \underbrace{P_{r_0} - \gamma \log \frac{r}{r_0}}_{\text{By human-made structure}} + \underbrace{20 \log \frac{h'_e}{h_1} + \alpha}_{\text{By terrain contour}} & (8.8-1) \\ \\ \text{Obstructive path} \\ = P_{r_0} - \gamma \log \frac{r}{r_0} + 20 \log \frac{h''_e}{h_1} + L + \alpha \text{ (where } h''_e \text{ is shown in Fig. 4.18a)} \\ = \underbrace{P_{r_0} - \gamma \log \frac{r}{r_0}}_{\text{By human-made structure}} + \underbrace{L + \alpha \text{ (when } h''_e \approx h_1)}_{\text{By terrain contour}} \\ \text{Land-to-mobile over water} = \text{a free-space formula} & \text{(see Sec. 8.2 and Sec. 8.3)} \end{cases}$$

1. The P_r cannot be higher than that from the free-space path loss.
2. The road's orientation, when it is within 2 mi from the cell site, will affect the received power at the mobile unit. The received power at the mobile unit traveling along an in-line road can be 10 dB higher than that along a perpendicular road.
3. α is the corrected factor (gain or loss) obtained from the condition (see Sec. 8.2.1).
4. The foliage loss (Sec. 8.4) would be added depending on each individual situation. Avoid choosing a cell site in the forest. Be sure that the antenna height at the cell site is higher than the top of the trees.
5. Within one mile (or one kilometer) in a man-made environment, the received signal is affected by the buildings and street orientations. The macrocell prediction formula (Eq. 8.8-1) can not be applied in such area. A microcell prediction model by Lee is introduced and described in Ref. 48.

The Merit of the Point-to-Point Model

The area-to-area model usually only provides an accuracy of prediction with a standard deviation of 8 dB, which means that 68 percent of the actual path-loss data are within the 8 dB of the predicted value. The uncertainty range is too large. The point-to-point model reduces the uncertainty range by including the detailed terrain contour information in the path-loss predictions.

The differences between the predicted values and the measured ones for the point-to-point model were determined in many areas. In the following discussion, we compare the differences shown in the Whippany, N.J., area and the Camden-Philadelphia area. First, we plot the points with predicted values at the x -axis and the measured values at the y -axis, shown in Fig. 8.20. The 45° line is the line of prediction without error. The dots are data from the Whippany area, and the crosses are data from the Camden-Philadelphia area. Most of them, except the one at 9 dB, are close to the line of prediction without error. The mean value of all the data is right on the line of prediction without error. The standard deviation of the predicted value of 0.8 dB from the measured one.

In other areas, the differences were slightly larger. However, the standard deviation of the predicted value never exceeds the measured one by more than 3 dB. The standard deviation range is much reduced as compared with the maximum of 8 dB from area-to-area models

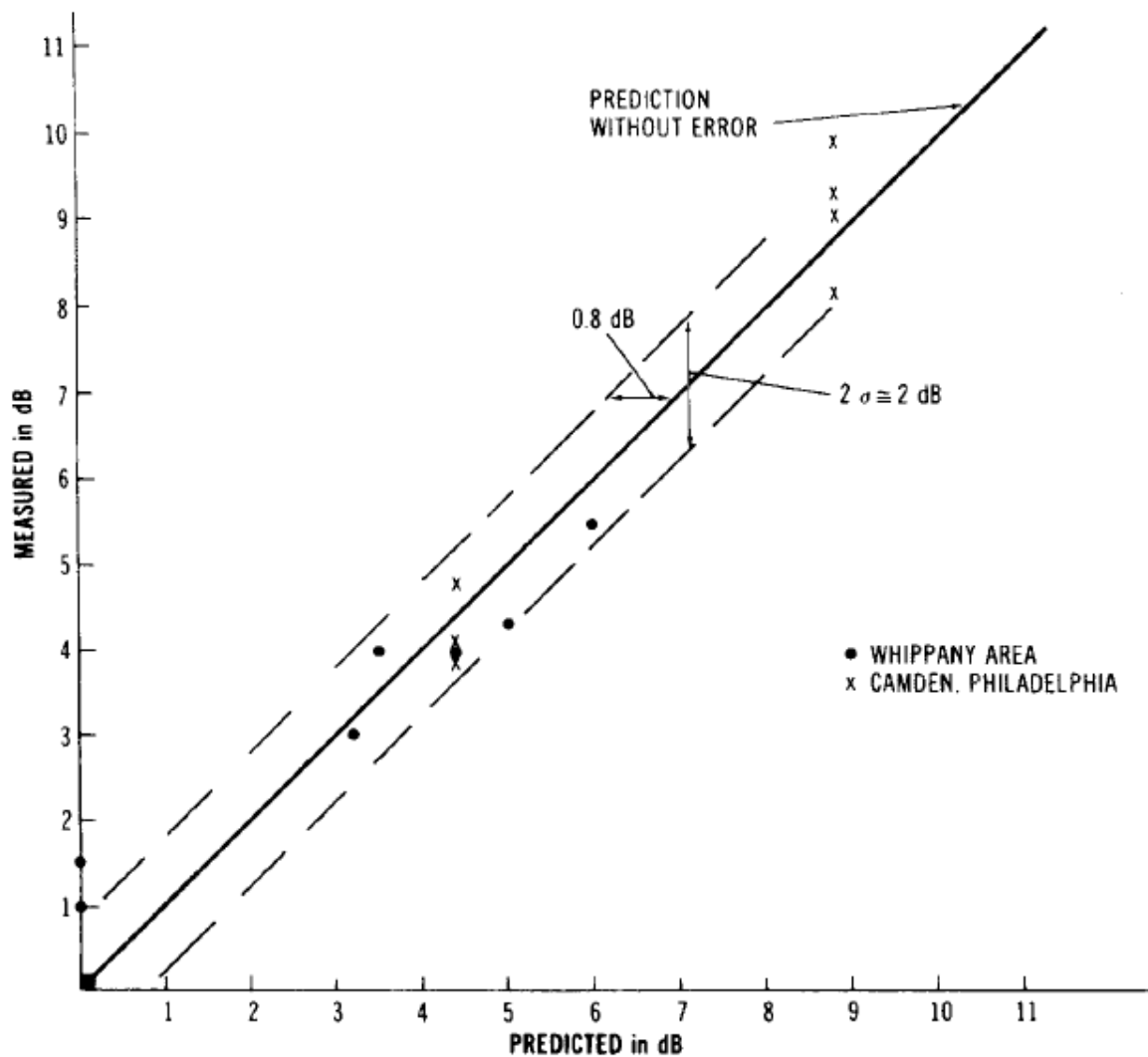

FIGURE 8.20 Indication of errors in point-to-point predictions under nonobstructive conditions. (After Lee, Ref. 43.)

The point-to-point model is very useful for designing a mobile cellular system with a radius for each cell of 10 mi or less. Because the data follow the log-normal distribution, 68 percent of predicted values obtained from a point-to-point prediction model are within 2 to 3 dB.

This point-to-point prediction can be used to provide overall coverage of all cell sites and to avoid cochannel interference. Moreover, the occurrence of handoff in the cellular system can be predicted more accurately.

The point-to-point prediction model is a basic tool that is used to generate a signal coverage map, an interference area map, a handoff occurrence map, or an optimum system design configuration, to name a few applications.

Module-V

For Coverage Use: Omnidirectional Antennas

8.13.1.1 High-Gain Antennas. There are standard 6-dB and 9-dB gain omnidirectional antennas. The antenna patterns for 6-dB gain and 9-dB gain are shown in Fig. 8.31.

Start-Up System Configuration. In a start-up system, an omnirelay, in which all the transmitting antennas are omnidirectional, is used. Each transmitting antenna can transmit signals from N radio transmitters simultaneously using a N-channel combiner or a broadband linear amplifier. Each cell normally can have three transmitting antennas which

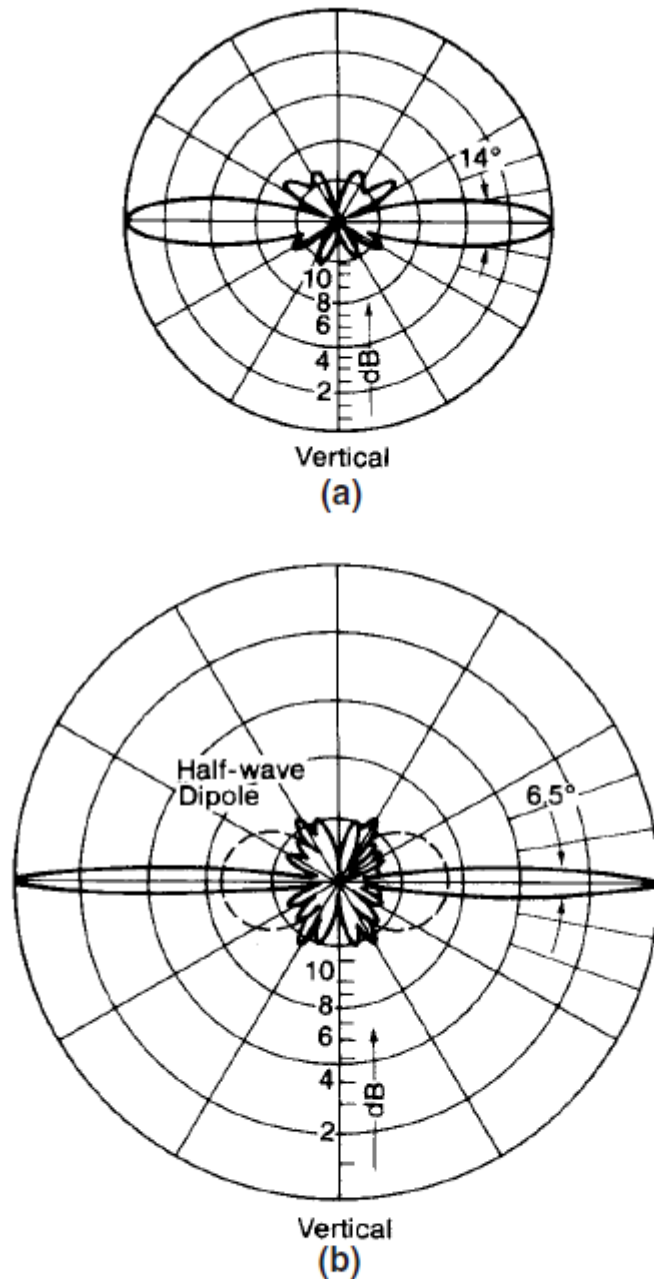

FIGURE 8.31 High-gain omnidirectional antennas (reprinted from *Kathrein Mobile Communications Catalog*). Gain with reference to dipole: (a) 6 dB; (b) 9 dB.

serve $3N$ voice radio transmitters* simultaneously. Each sending signal is amplified by its own channel amplifier in each radio transmitter, or N channels (radio signals) pass through a broadband linear amplifier and transmit signals by means of a transmitting antenna (see Fig. 8.32a).

Two receiving antennas commonly can receive all $3N$ voice radio signals simultaneously. Then in each channel, two identical signals received by two receiving antennas pass through a diversity receiver of that channel. The receiving antenna configuration on the antenna mast is shown in Fig. 8.32. The separation of antennas for a diversity receiver is discussed in Sec. 8.14. For serving $6N$ voice radio transmitters from six transmitting antennas is shown in Fig. 8.32(b).

8.13.1.3 Abnormal Antenna Configuration. Usually, the call traffic in each cell increases as the number of customers increases. Some cells require a greater number of radios to handle the increasing traffic. An omniscell site can be equipped with up to 90 voice radios for AMPS systems. In such cases six transmitting antennas should be used as shown in Fig. 8.32b. In the meantime, the number of receiving antennas is still two. In order to reduce the number of transmitting antennas, a hybrid ring combiner that can combine two 16-channel signals is found.⁵³ This means that only three transmitting antennas are needed to transmit 90 radio signals. However, the ring combiner has a limitation of handling power up to 600 W with a loss of 3 dB.

8.13.2 For Interference Reduction Use: Directional Antennas

When the frequency reuse scheme must be used in AMPS, cochannel interference will occur. The cochannel interference reduction factor $q = D/R = 4.6$ is based on the assumption that the terrain is flat. Because actual terrain is seldom flat, we must either increase q or use directional antennas.

8.13.2.1 Directional Antennas. A 120° -corner reflector or 120° -plane reflector can be used in a 120° -sector cell. A 60° -corner reflector can be used in a 60° -sector cell. A typical pattern for a directional antenna of 120° beamwidth is shown in Fig. 8.33.

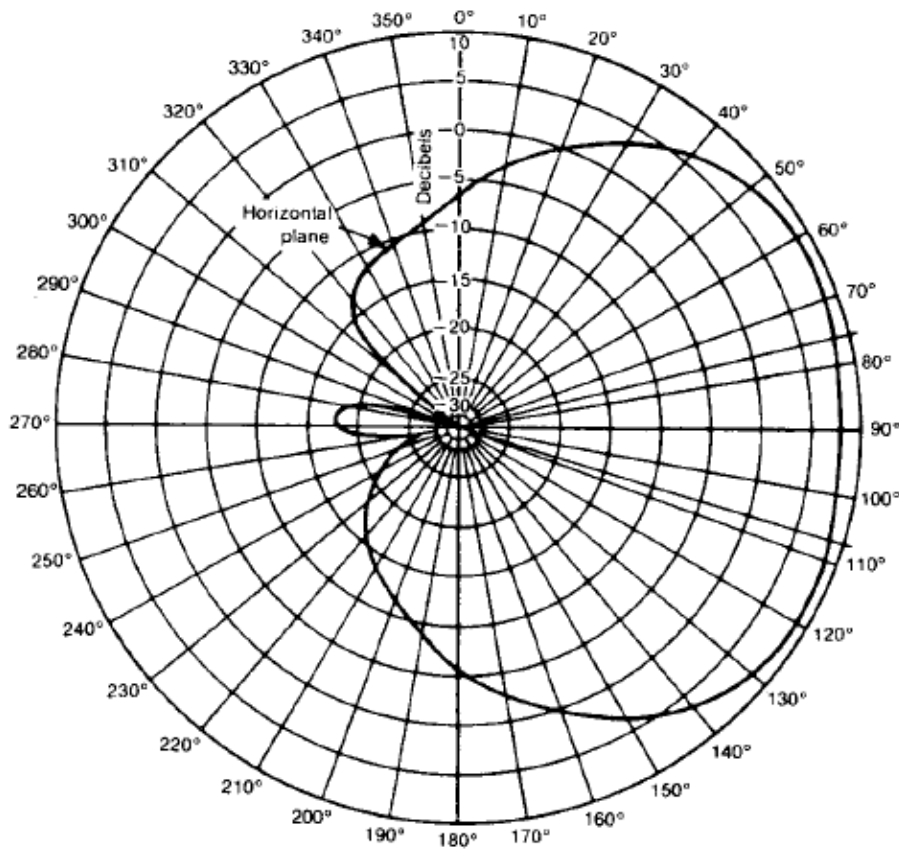

(a)

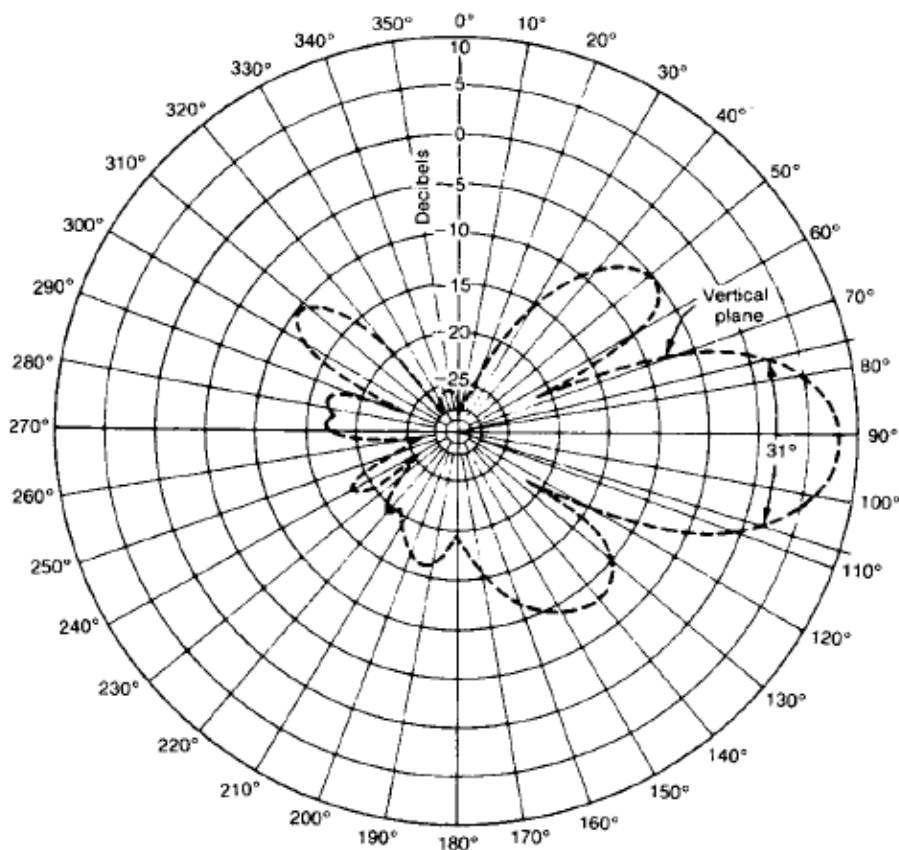

(b)

FIGURE 8.33 A typical 8-dB directional antenna pattern. (Reprinted from *Bell System Technical Journal*, Vol. 58, January 1979, pp. 224–225.) (a) Azimuthal pattern of 8-dB directional antenna. (b) Vertical pattern of 8-dB directional antenna.

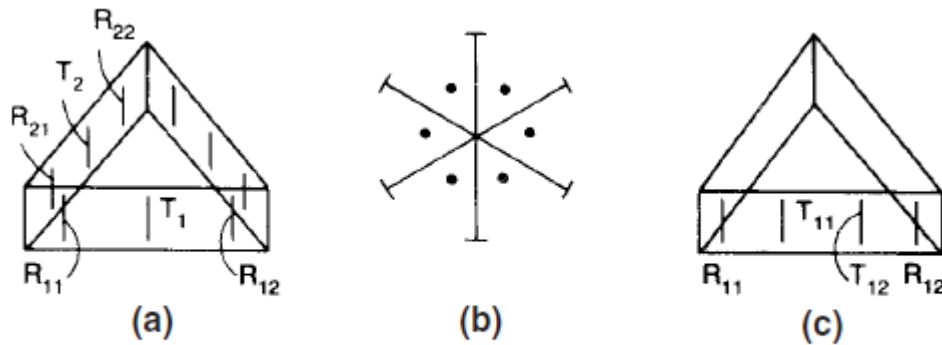

FIGURE 8.34 Directional antenna arrangement: (a) 120° sector (45 radios); (b) 60° sector; (c) 120° sector (90 radios).

space diversity antennas,

8.13.5 Space-Diversity Antennas Used at Cell Site

Two-branch space-diversity antennas are used at the cell site to receive the same signal with different fading envelopes, one at each antenna. The degree of correlation between two fading envelopes is determined by the degree of separation between two receiving antennas. When the two fading envelopes are combined, the degree of fading is reduced; this improvement is discussed in Ref. 55. Here the antenna setup is shown in Fig. 8.35a. Equation (8.13-1) is presented as an example for the designer to use.

$$\eta = \frac{h}{D} = 11 \quad (8.13-1)$$

where h is the antenna height and D is the antenna separation. From Eq. (8.13-1), the separation $d \geq 8\lambda$ is needed for an antenna height of 100 ft (30 m) and the separation $d \geq 14\lambda$ is needed for an antenna height of 150 ft (50 m). In any omniscell system, the two space-diversity antennas should be aligned with the terrain, which should have a U shape⁵⁶ as shown in Fig. 8.35b.

Space-diversity antennas can separate only horizontally, not vertically; thus, there is no advantage in using a vertical separation in the design.⁵⁶ The use of space-diversity antennas at the base station is discussed in detail in Ref. 56.

umbrella pattern antennas,

In certain situations, umbrella-pattern antennas should be used for the cell-site antennas.

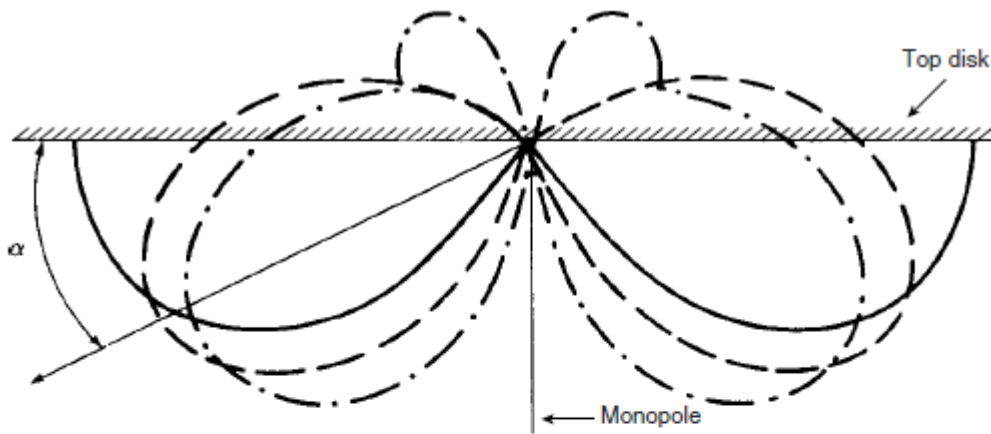

FIGURE 8.36 Vertical-plane patterns of quarter-wavelength stub antenna on infinite ground plane (solid) and on finite ground planes several wavelengths in diameter (dashed line) and about one wavelength in diameter (dotted line). (After Kraus, Ref. 14.)

13.6.1 Normal Umbrella-Pattern Antenna.⁵⁷ For controlling the energy in a confined area, the umbrella-pattern antenna can be developed by using a monopole with a top disk (top-loading) as shown in Fig. 8.36. The size of the disk determines the tilting angle of the pattern. The smaller the disk, the larger the tilting angle of the umbrella pattern.

13.6.2 Broadband Umbrella-Pattern Antenna.⁵⁸ The parameters of a *discone antenna* (a bioconical antenna in which one of the cones is extended to 180° to form a disk) are shown in Fig. 8.37a. The diameter of the disk, the length of the cone, and the opening angle of the cone can be adjusted to create an umbrella-pattern antenna as described in Ref. 58.

13.6.3 High-Gain Broadband Umbrella-Pattern Antenna. A high-gain antenna can be constructed by vertically stacking a number of umbrella-pattern antennas as shown in Fig. 8.37b.

$$E_0 = \frac{\sin[(Nd/2\lambda) \cos \phi]}{\sin[(d/2\lambda) \cos \phi]} \cdot (\text{individual umbrella pattern})$$

here ϕ = direction of wave travel
 N = number of elements
 d = spacing between two adjacent elements

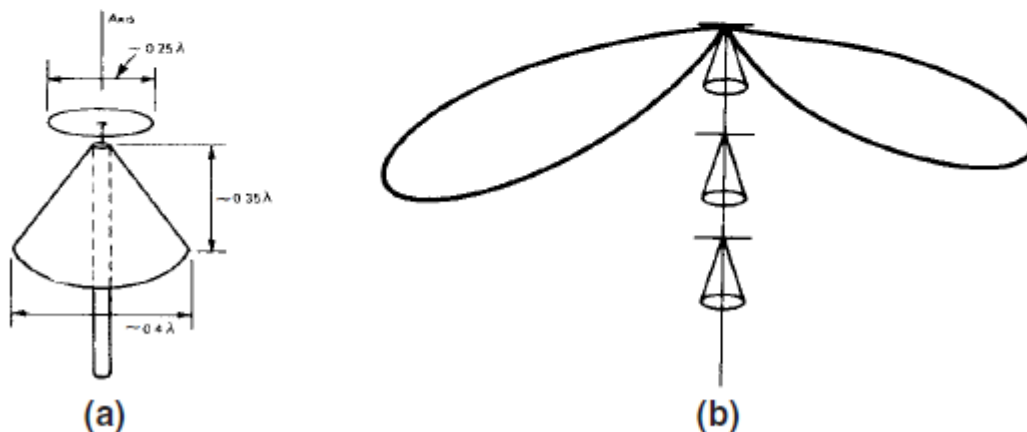

FIGURE 8.37 Discone antennas. (a) Single antenna. (b) An array of antennas.

minimum separation of cell site antennas,

Minimum Separation of Cell-Site Receiving Antennas

Separation between two transmitting antennas should be minimized to avoid the intermodulation discussed in Chap. 10. The minimum separation between a transmitting antenna and a receiving antenna necessary to avoid receiver desensitization is also described in Chap. 10. Here we are describing a minimum separation between two receiving antennas to reduce the antenna pattern ripple effects.

The two receiving antennas are used for a space-diversity receiver. Because of the nearfield disturbance due to the close spacing, ripples will form in the antenna patterns (Fig. 8.40). The difference in power reception between two antennas at different angles of arrival is shown in Fig. 8.40. If the antennas are located closer; the difference in power between two antennas at a given pointing angle increases. Although the power difference is confined to a small sector, it affects a large section of the street as shown in Fig. 8.40. If the power difference is excessive, use of a space diversity will have no effect reducing fading. At 850 MHz, the separation of eight wavelengths between two receiving antennas creates a power difference of 2 dB, which is tolerable for the advantageous use of a diversity scheme.

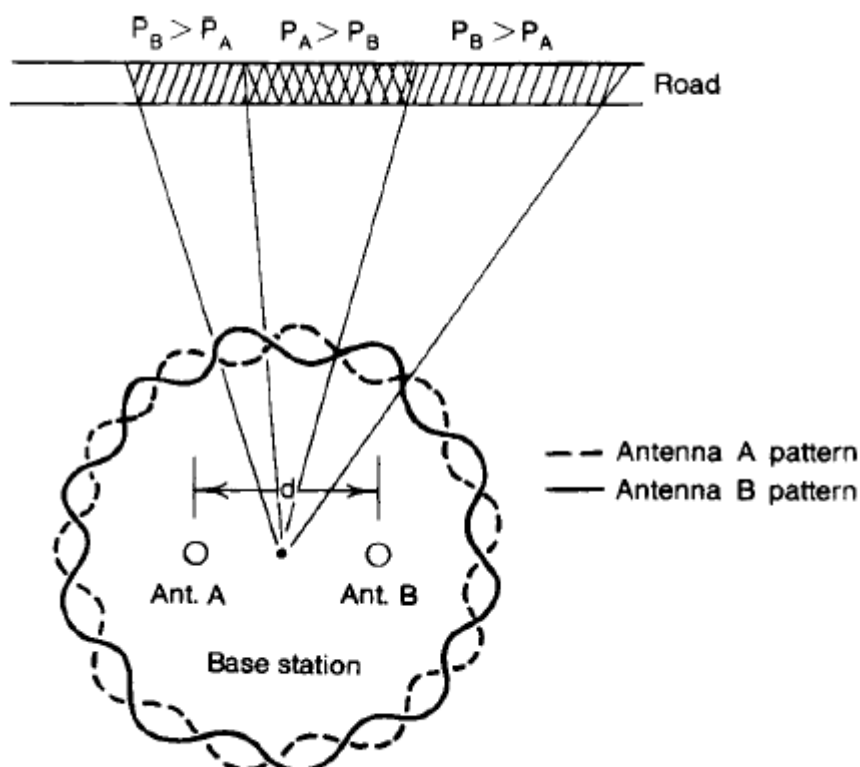

FIGURE 8.40 Antenna pattern ripple effect.

high gain antennas.

A high-gain antenna used on a mobile unit has been studied.⁶⁸ This type of high-gain antenna should be distinguished from the directional antenna. In the directional antenna, the antenna beam pattern is suppressed horizontally; in the high-gain antenna, the pattern is suppressed vertically. To apply either a directional antenna or a high-gain antenna for reception in a radio environment, we must know the origin of the signal. If we point the directional antenna opposite to the transmitter site, we would in theory receive nothing. In a mobile radio environment, the scattered signals arrive at the mobile unit from every direction with equal probability. That is why an omnidirectional antenna must be used. The scattered signals also arrive from different elevation angles. Lee and Brandt⁶⁸ used two types of antenna, one $\lambda/4$ whip antenna with an elevation coverage of 39° and one 4-dB-gain antenna (4-dB gain with respect to the gain of a dipole) with an elevation coverage of 16° , and measured the angle of signal arrival in the suburban Keyport-Matawan area of New Jersey. There are two types of test: a line-of-sight condition and an out-of-sight condition. In Lee and Brandt's study, the transmitter was located at an elevation of approximately 100 m (300 ft) above sea level. The measured areas were about 12 m (40 ft) above sea level and the path length about 3 mi. The received signal from the 4-dB-gain antenna was 4 dB stronger than that from the whip antenna under line-of-sight conditions. This is what we would expect. However, the received signal from the 4-dB-gain antenna was only about 2 dB stronger than that from the whip antenna under out-of-sight conditions. This is surprising. The reason for the latter observation is that the scattered signals arriving under out-of-sight conditions are spread over a wide elevation angle. A large portion of the signals outside the elevation angle of 16° cannot be received by the high-gain antenna. We may calculate the portion being received by the high-gain antenna from the measured beamwidth. For instance, suppose that a 4:1 gain (6 dBi) is expected from the high-gain antenna, but only 2.5:1 is received. Therefore, 63 percent of the signal* is received by the 4-dB-gain antenna (i.e., 6 dBi) and 37 percent is felt in the region between 16° and 39° .

| | Gain, dBi | Linear ratio | $\theta_0/2$, degrees |
|-------------------------------------|-----------|--------------|------------------------|
| Whip antenna (2 dB above isotropic) | 2 | 1.58:1 | 39 |
| High-gain antenna | 6 | 4:1 | 16 |
| Low-gain antenna | 4 | 2.5:1 | 24 |

UNIT-7

Handoff, dropped calls :

In an analog system, once a call is established, the set-up channel is not used again during the call period. Therefore, handoff is always implemented on the voice channel. In the digital systems, the handoff is carried out through paging or common control channel. The value of implementing handoffs is dependent on the size of the cell. For example, if the radius of the cell is 32 km (20 mi), the area is 3217 km² (1256 mi²). After a call is initiated in this area, there is little chance that it will be dropped before the call is terminated as a result of a weak signal at the coverage boundary. Then why bother to implement the handoff feature? Even for a 16-km radius, cell handoff may not be needed. If a call is dropped in a fringe area, the customer simply redials and reconnects the call. Today the size of cells becomes smaller in order to increase capacity. Also people talk longer. The handoffs are very essential.

Handoff is needed in two situations where the cell site receives weak signals from the mobile unit: (1) at the cell boundary, say, -100 dBm, which is the level for requesting a handoff in a noise-limited environment; and (2) when the mobile unit is reaching the signal-strength holes (gaps) within the cell site

Types of handoff,

In digital systems there are different types of handoff, but in an analog system, there is only one type of handoff, which is the hard handoff.

A. Natures of handoff

1. Hard handoff: This is a break-before-make process and handoff between two frequencies.

All FDMA, TDMA, and OFDMA digital systems, and analog systems, can perform hard handoffs.

2. Soft handoff: This is a make-before-break process. Because CDMA has to perform the handoff between two code channels, not two frequencies, it is difficult to perform the hard handoffs. Because of the soft handoffs, the process needs to secure two code channels during the handoff process. Therefore, the capacity is reduced in the soft handoff region, but the drop call is reduced also due to the diverse nature of switching two code channels.

3. Softer handoff: Handoff occurring between sectors only at the serving cell. It is a make-before-break type using combined diversity of two code channels.

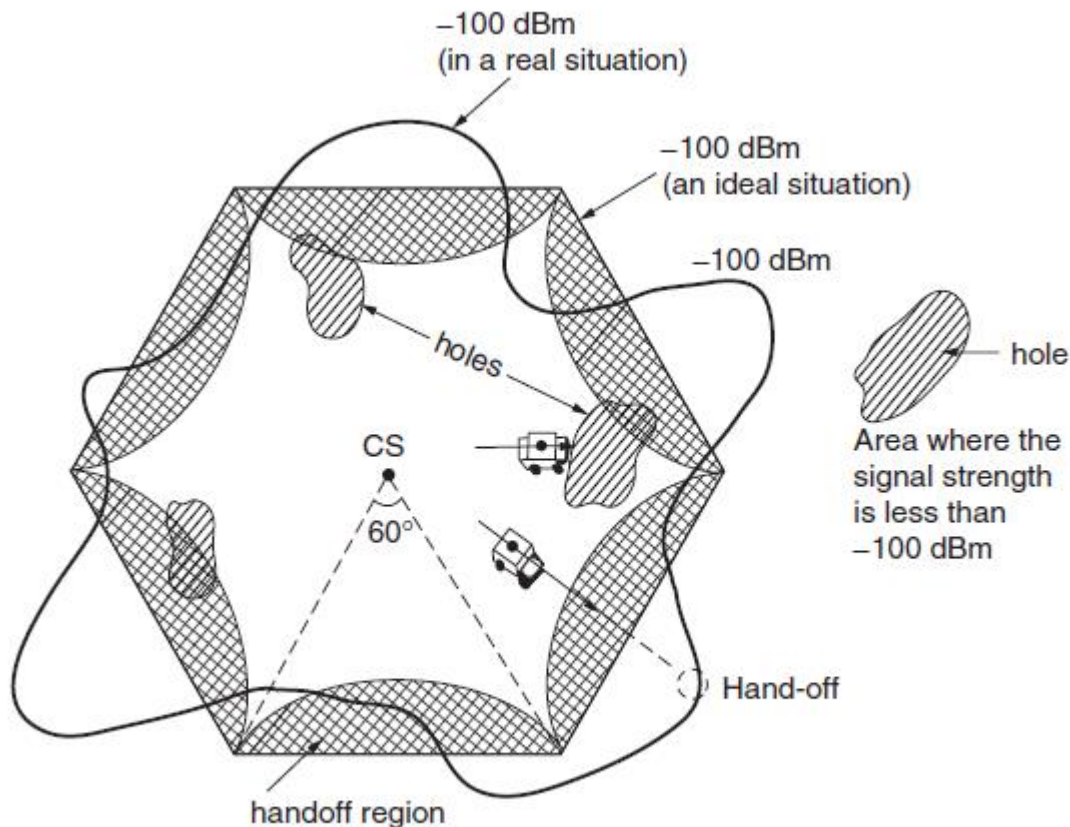

FIGURE 11.1 Occurrence of handoff.

Purposes of handoff

1. Intracell handoff: can be a sector-to-sector handoff.
2. Intercell handoff: a handoff from an old cell to a new cell.
3. Inter BSC/MSC handoff: using compressed mode, referred to as the slotted mode. In this mode, the transmission and reception are halted for a short time, of the order a few milliseconds, in order to perform measurements on the other frequencies from other systems.
4. Intersystem handoff: handoff between two same type systems.
5. Inter-carrier handoffs: handoff occurs between two carriers.
6. Inter-mode handoff: the handoff occurs from one of the modes TDMA, CDMA, GSM, and GPRS to another mode.

C. Algorithms of handoff

1. MCHO (Mobile Control Handoff): It is the responsibility of MS to choose the best BS.
2. NCHO (Network Control Handoff): It is the responsibility of network to choose the best BS.
3. NCHO/MAHO (Network Control Handoff/Mobile Assists Handoff): It is the responsibility of network to choose the best BS, but with the information supplied by the

delaying handoff,

In many cases, a two-handoff-level algorithm is used. The purpose of creating two request handoff levels is to provide more opportunity for a successful handoff. A handoff could be delayed if no available cell could take the call.

A plot of signal strength with two request handoff levels and a threshold level is shown in Fig. 11.4. The plot of average signal strength is recorded on the channel received

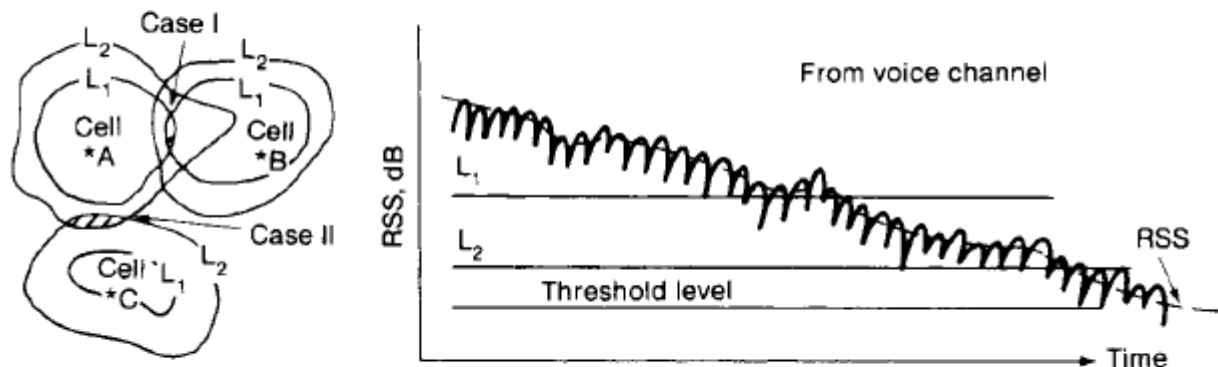

FIGURE 11.4 A two-level handoff scheme.

signal-strength indicator (RSSI), which is installed at each channel receiver at the cell site. When the signal strength drops below the first handoff level, a handoff request is initiated. If for some reason the mobile unit is in a hole (a weak spot in a cell) or a neighboring cell is busy, the handoff will be requested periodically every 5 s. At the first handoff level, the handoff takes place if the new signal is stronger (see case I in Fig. 11.4). However, when the second handoff level is reached, the call will be handed off with no condition (see case II in Fig. 11.4).

The MSO always handles the handoff call first and the originating calls second. If no neighboring calls are available after the second handoff level is reached, the call continues until the signal strength drops below the threshold level; then the call is dropped. In AMPS systems if the supervisory audio tone (SAT) is not sent back to the cell site by the mobile unit within 5 s, the cell site turns off the transmitter.

forced handoff:

A *forced handoff* is defined as a handoff that would normally occur but is prevented from happening, or a handoff that should not occur but is forced to happen.

Controlling a Handoff

The cell site can assign a low handoff threshold in a cell to keep a mobile unit in a cell longer or assign a high handoff threshold level to request a handoff earlier. The MSO also

can control a handoff by making either a handoff earlier or later, after receiving a handoff request from a cell site.

Creating a Handoff

In this case, the cell site does not request a handoff but the MSO finds that some cells are too congested while others are not. Then, the MSO can request cell sites to create early handoffs for those congested cells. In other words, a cell site has to follow the MSO's order and increase the handoff threshold to push the mobile units at the new boundary and to hand off earlier.

mobile assigned handoff:

In a normal handoff procedure, the request for a handoff is based on the signal strength (or the SAT range of AMPS) of a mobile signal received at the cell site from the reverse link. In the digital cellular system, the mobile receiver is capable of monitoring the signal strength of the setup channels of the neighboring cells while serving a call. For instance, in a TDMA system, one time slot is used for serving a call, the rest of the time slots can be used to monitor the signal strengths of setup channels. When the signal strength of its voice channel is weak, the mobile unit can request a handoff and indicate to the switching office which neighboring cell can be a candidate for handoff. Now the switching office has two pieces of information: the signal strengths of both forward and reverse setup channels of a neighboring cell or two different neighboring cells. The switching office (MSO) therefore, has more intelligent information to choose the proper neighboring cell to handoff to.

The soft handoff is applied to one kind of digital cellular system named CDMA. In CDMA systems, all cells can use the same radio carrier. Therefore, the frequency reuse factor K approaches one. Because the operating radio carriers of all cells are the same, no need to change from one frequency to another frequency but change from one code to another code. Thus, there is no hard handoff. We call this kind of handoff a soft handoff. If sometimes there are more than one CDMA radio carrier operating in a cell, and if the soft handoff from one cell to another is not possible for some reason, the intracell hard handoff may take place first, then go to the inter-cell soft handoff.

Intersystem handoff:

Occasionally, a call may be initiated in one cellular system (controlled by one MSO)* and enter another system (controlled by another MSO) before terminating. In some instances, *intersystem handoff* can take place; this means that a call handoff can be transferred from

one system to a second system so that the call be continued while the mobile unit enters the second system.

The software in the MSO must be modified to apply this situation. Consider the simple diagram shown in Fig. 11.10. The car travels on a highway and the driver originates a call in system A. Then the car leaves cell site A of system A and enters cell site B of system B.

Cell sites A and B are controlled by two different MSOs. When the mobile unit signal becomes weak in cell site A, MSO A searches for a candidate cell site in its system and cannot find one. Then MSO A sends the handoff request to MSO B through a dedicated line between MSO A and MSO B, and MSO B makes a complete handoff during the call conversation. This is just a one-point connection case. There are manyways of implementing intersystem handoffs, depending on the actual circumstances. For instance, if two MSOs are manufactured by different companies, then compatibility must be determined before implementation of intersystem handoff can be considered

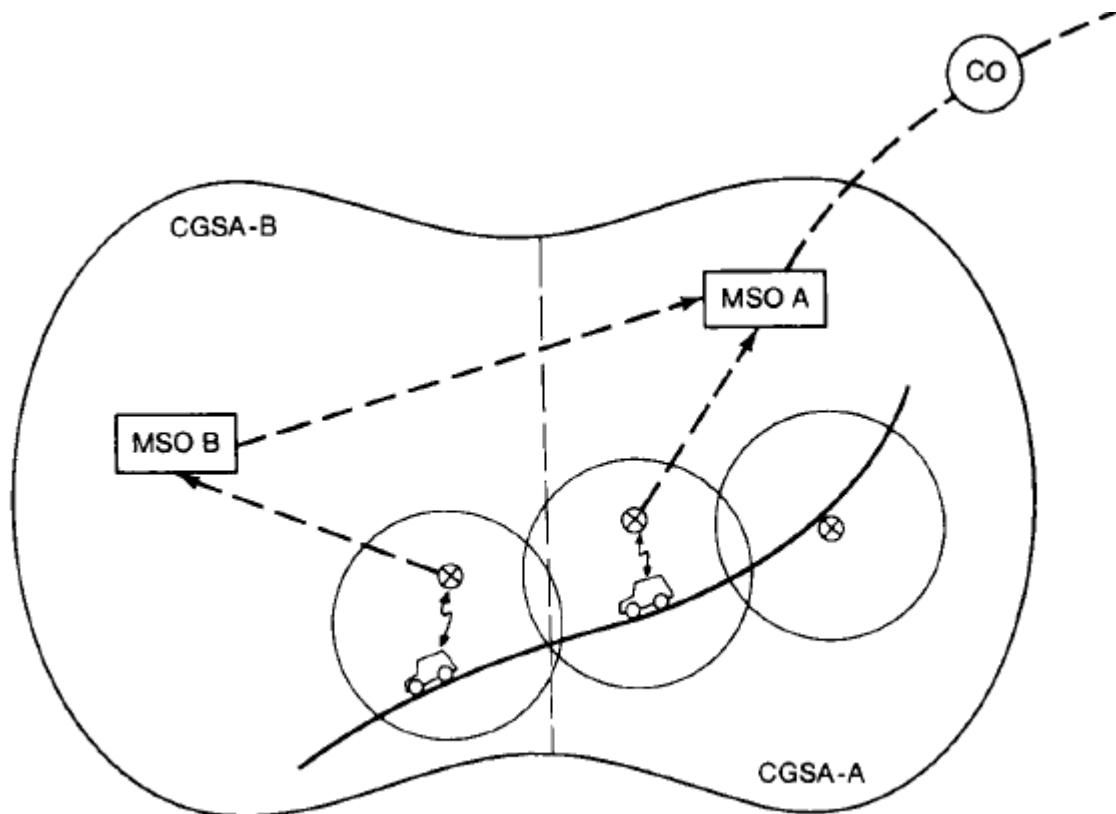

FIGURE 11.10 Intersystem handoffs.

dropped call rates and their evaluation:

The definition of a dropped call is after the call is established but before it is properly terminated. The definition of “the call is established” means that the call is setup completely by the setup channel. If there is a possibility of a call drop due to no available voice channels, this is counted as a blocked call not a dropped call.

If there is a possibility that a call will drop due to the poor signal of the assigned voice

channel, this is considered a dropped call. This case can happen when the mobile or portable units are at a standstill and the radio carrier is changed from a strong setup channel to a weak voice channel due to the selective frequency fading phenomenon.

The perception of dropped call rate by the subscribers can be higher due to:

1. The subscriber unit not functioning properly (needs repair).
2. The user operating the portable unit in a vehicle (misused).
3. The user not knowing how to get the best reception from a portable unit (needs education).

Consideration of Dropped Calls

In principle, dropped call rate can be set very low if we do not need to maintain the voice quality. The dropped call rate and the specified voice quality level are inversely proportional.

In designing a commercial system, the specified voice quality level is given relating to how much C/I (or C/N) the speech coder can tolerate. By maintaining a certain voice quality level, the dropped call rate can be calculated by taking the following factors into

consideration of dropped calls:

1. Provide signal coverage based on the percentage (say 90 percent) that all the received signal will be above a given signal level.
2. Maintain the specified co-channel and adjacent channel interference levels in each cell during a busy hour (i.e., the worst interference case).
3. Because the performance of the call dropped rate is calculated as possible call dropping in every stage from the radio link to the PSTN connection, the response time of the handoff in the network will be a factor when the cell becomes small, the response time for a handoff request has to be shorter in order to reduce the call dropped rate.

UNIT-8

DIGITAL CELLULAR NETWORKS:

A **cellular network** is a [radio](#) network distributed over land areas called cells, each served by at least one fixed-location [transceiver](#) known as a [cell site](#) or [base station](#). When joined together these cells provide radio coverage over a wide geographic area. This enables a large number of portable transceivers (e.g., [mobile phones](#), pagers, etc.) to communicate with each other and with fixed transceivers and telephones anywhere in the network, via base stations, even if some of the transceivers are moving through more than one cell during transmission.

Cellular networks offer a number of advantages over alternative solutions:

- increased capacity
- reduced power use
- larger coverage area
- reduced interference from other signals

An example of a simple non-telephone cellular system is an old [taxi](#) driver's radio system where the taxi company has several transmitters based around a city that can communicate directly with each taxi.

In a [cellular radio](#) system, a land area to be supplied with radio service is divided into regular shaped cells, which can be hexagonal, square, circular or some other irregular shapes, although hexagonal cells are conventional. Each of these cells is assigned multiple frequencies ($f_1 - f_6$) which have corresponding [radio base stations](#). The group of frequencies can be reused in other cells, provided that the same frequencies are not reused in adjacent neighboring cells as that would cause [co-channel interference](#).

The increased [capacity](#) in a cellular network, compared with a network with a single transmitter, comes from the fact that the same radio frequency can be reused in a different area for a completely different transmission. If there is a single plain transmitter, only one transmission can be used on any given frequency. Unfortunately, there is inevitably some level of [interference](#) from the signal from the other cells which use the same frequency. This means that, in a standard FDMA system, there must be at least a one cell gap between cells which reuse the same frequency.

In the simple case of the taxi company, each radio had a manually operated channel selector knob to tune to different frequencies. As the drivers moved around, they would change from channel to channel. The drivers know which [frequency](#) covers approximately what area. When they do not

receive a signal from the transmitter, they will try other channels until they find one that works. The taxi drivers only speak one at a time, when invited by the base station operator (in a sense [TDMA](#)).